



ALWAYS PROTECTED.
ALWAYS CONNECTED.[®]
DISCOVER GDS[®] GREEN[™]



GDS® REACH™ POWERED BY GDS® TECHNOLOGY™

Always protected, always connected—it's not just a tagline, it's a promise. When you see the distinctive, recognizable GDS® Green™ color while shopping for chargers, docks, and skins, you know you can count on quality and reliability. The GDS® Ecosystem™ provides protection, charging, and data sync capabilities across a wide range of electronic devices, making it a perfect solution for business applications like agriculture, fleet transportation, material handling, retail, and much more. With GDS® Compatible™ IntelliSkin® protective sleeves and GDS® Tech™ pogo pin technology-enabled docks and accessories, simplify the process of upgrading devices while taking advantage of a standardized charging and data transfer ecosystem.



Protect

IntelliSkin® provides GDS® charging capabilities and military-grade drop protection. By eliminating the frequent plugging and unplugging of consumer-oriented devices in business and field applications, extend the life of electronic devices in any application.



Connect

Ruggedized GDS® Technology™ pogo pins ensure a standardized compatibility across the GDS® Ecosystem™ —from IntelliSkin® sleeves and GDS® Docks™ to adapters, chargers, keyboards, speakers, monitors, and more.



Enhance

Streamline your workflow with GDS® Reach™ together with a wide variety of compatible accessories, including RAM® Mounts. Our proprietary double ball and socket system sets the industry standard for adjustability, durability, and vibration damping.



Futureproof

As devices evolve, IntelliSkin® and GDS® Tech™ provide cost-effective scalability and enables users to deploy devices with one standard for charging and data transfer. When it comes time to upgrade, experience a seamless transition with GDS® Docks™ interchangeable top latches and powered bottom cup.

TABLE OF CONTENTS

How it Works: IntelliSkin®	pg. 3	Universal Tablet Docks	pg. 29
How it Works: GDS® Tough-Docks™	pg. 5	Universal Phones Docks	pg. 31
Case Studies	pg. 7	Desktop Docks	pg. 33
Transportation Bundles	pg. 9	Tough-Hub™ & Samsung DeX	pg. 35
Forklift Bundles	pg. 11	GDS® View™	pg. 37
& Laptop In-Vehicle Bundles		GDS® Keyboard™	pg. 39
Modular Components	pg. 13	GDS® Audio™	pg. 41
& Input Devices		GDS® Slide Dock™	pg. 43
Samsung XCover6 Pro	pg. 15	Phone Cabinet Module	pg. 45
Zebra Handhelds	pg. 17	Chargers	pg. 47
Zebra ET40 & ET45	pg. 19	Cables and Cable Retention	pg. 49
Zebra Desktop Docks	pg. 21	Care & Maintenance	pg. 51
GDS® Ergo	pg. 23	Compatibility Charts	pg. 53
Temperature Control	pg. 25	Legacy Products	pg. 57
RAM® NFC Extender	pg. 27		



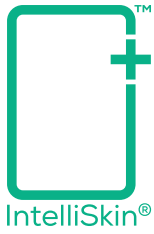

How it Works IntelliSkin®

The GDS® Reach™ platform provides protection, charging, and data sync capabilities across a wide range of electronic devices, making it a perfect solution for fleet deployment. With GDS® Compatible™ IntelliSkin® protective sleeves, GDS® Docks™, and GDS® Ecosystem™ accessories, simplify the process of scaling and upgrading devices while taking advantage of a standardized charging and data transfer ecosystem.



SEEN IN THIS PHOTO:

RAM-GDS-SKIN-SAM67-NG-LED
IntelliSkin® Next Gen with LED Light
for Samsung Tab A 8.4 SM-T307



Drop Protection

IntelliSkin® sleeves are MIL-STD-810H drop protection certified, protecting your devices from the shock and impact of harsh environments.

SEEN IN THIS PHOTO:

RAM-GDS-SKIN-AP32-NG
IntelliSkin® for Apple iPad Air 5



Built-in LED

Select IntelliSkin® cases have a built-in LED option for those limited light situations when you need a flashlight in a pinch.

◀ **RAM-GDS-SKIN-SAM80-NG-LED**
IntelliSkin® with LED Light for Samsung Tab A7 Lite 8.7"



Ergo Accessories

The GDS® Hand-Stand™ Hand Strap with Kickstand works with most tablet IntelliSkin® for an easy way to take advantage of workstation enablement.

◀ **RAM-GDS-HS1U**
GDS® Hand-Stand™ Hand Strap and Kickstand for Tablets

Hundreds of Devices Supported





How it Works

The GDS® Tough-Dock™

The GDS® Tough-Dock™ is a rugged, modular frame for IntelliSkin®-wrapped devices that are highly customizable to your business needs. These docks are key to the GDS® Reach™ experience – standardized charging, data transfer, and simplified scaling.



Supports
RAM® NFC Extender
pg. 27



AMPS
Mounting Pattern



Supports Temperature
Control Accessories
pg. 25

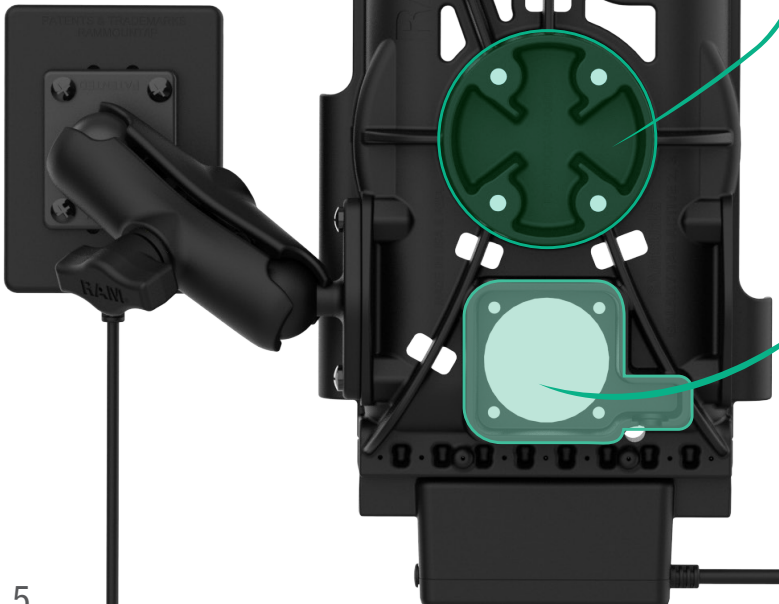



6-PORT DOCKS
 pg.33



PHONE DOCKS
 pg.31



TOUGH-DOCKS™
 pg.9



ERGONOMIC ACCESSORIES
 pg.23



TOUGH-HUB™
 pg.35



DESKTOP DOCKS
 pg.33

ALWAYS PROTECTED.
 ALWAYS CONNECTED.®

Connective Longevity and RFID Compatibility with GDS® Tech™

One of the leading student transportation solutions providers, First Student, has spent years curating the very best products to bring the Connected Highway vision to the education industry. In doing so, First Student has successfully transitioned thousands of districts all over the US to include centralized vehicle telematics and student tracking integrated into their buses. The entire workflow centers around in-cab tablets, tailored software, and RFID technology. In order to enable this new system, First Student enlists the help of RAM® Mounts, Samsung, and student tracking software like SMART tag™, TylerTech, and EDULOG.



RAM-GDS-DOCKL-SAM62CP-NFCU
Locking GDS® Tough-Dock™ for Tab Active3 with RAM® NFC Reach™

THE RAM® MOUNTS SOLUTION

In order for First Student to deploy telematics solutions, they needed secure vehicle docks with a reliable connection to power and peripherals. RAM® Mounts recommended the game-changing GDS® Tech™ system. Known for connective longevity, First Student noticed the GDS® system performed better than conventional mounting solutions. This was due to the protective and connective nature of a device wrapped with IntelliSkin®, the component that allows the GDS® system to work.

School buses being as dirty as they normally are, the IntelliSkin® protects the device's USB ports and converts the connection point to pogo pin contacts making it easier to clean and maintain charge upon docking.

The second requirement from First Student was the ability to use RFID, or NFC peripheral devices to enable student tracking. Fortunately, GDS® Docks™ are modular and RAM® offers docking cups that allow for additional USB-A peripherals such as the SMART tag™ RFID reader, as well as RAM®'s patented NFC Extender. RAM® rounds off each solution with their famous, and customizable, double ball and socket mounts.

OUR PRODUCT SOLUTIONS



RAM-GDS-SKIN-SAM74-NG
IntelliSkin® Next Gen for Samsung Tab Active3



RAM-GDS-DOCKL-SAM62CP-NFCU
Locking GDS® Tough-Dock™ for Tab Active3 with RAM® NFC Extender



RAM-101-B-225B2U
RAM® Drill-Down Dashboard Mount with Backing Plate - C Size Short



RAM-GDS-CHARGE-V3C-2U
GDS® Modular 10-30V Power Delivery Hardwire Charger with Male USB Type-C



RAM-GDS-HS1U
GDS® Hand-Stand™ Hand Strap and Kickstand for Tablets



RAM-GDS-CAB-CLAMP1U
GDS® mUSB & Type-C Cable Clamp



RAM® Plays Pivotal Role in New High-Tech Recycling Smart Trucks

North America's largest recycler of post-consumer materials has developed groundbreaking automated recycling technology and successfully deployed it in thousands of its collection trucks across the continent. In essence, this innovative system utilizes artificial intelligence to identify and analyze recycling challenges, ultimately enhancing overall efficiency. Recent studies conducted by this organization and its affiliates have revealed that a significant majority of consumers express confusion regarding proper recycling practices, leading to the disposal of unusable mixed materials. With the advent of this state-of-the-art technology, the aim of this prominent recycling company is to eradicate any guesswork associated with recycling processes.



RAM-GDS-SKIN-SAM74-NG
IntelliSkin® Next Gen for Samsung Tab Active3

RAM-GDS-DOCK-SAM62CPU
GDS® Tough-Dock™ for Tab Active3

THE RAM® MOUNTS SOLUTION

When these smart trucks collect recyclables from customer bins, a cutting-edge system kicks into gear. Live cameras and sensors scan the materials, while the AI centralizes the data and uncovers opportunities for service improvements. Challenges include overfilled containers, bins not placed out for service, and incorrect recycling materials. For this system to work, each driver is equipped with a Samsung Tab Active3 and a RAM® Mounts docking solution. In this case, the large recycling organization needed a scalable solution and RAM®'s connective product line "GDS® Tech™ & IntelliSkin®" was the ideal choice to deploy in thousands of trucks. The goal was to ruggedize the system, keep devices charged, and connect the tablet to the vehicle's gateway where data from the AI program, as well as vehicle diagnostics, are stored.



Georgia-Pacific Keeps One Eye on Tomorrow

When Georgia-Pacific determined that new devices were necessary to run the latest software and security updates required for their manufacturing plants, they kept two characteristics in mind: flexibility and ease of updates. As a global leader, custom applications and solutions are needed to continue cutting-edge innovation.

THE RAM® MOUNTS SOLUTION

The GDS® Tech™'s standardized ecosystem is a future-proofed model that provides protection, charging, and data sync capabilities for fleets of devices. Our three-part system starts with a device-specific IntelliSkin® case featuring MIL-STD-810H drop protection, ruggedized GDS® Tech™ pogo pins, and integrated USB Type-C connector. The integrated pogo pin connection ensures your devices are always connected—making it simple to keep your devices powered while protecting the device ports from breakage due to constant plugging and unplugging.



RAM-GDS-SKIN-SAM54-NG-1
IntelliSkin® Next Gen for Samsung Tab Active4 Pro & Tab Active Pro

RAM-GDS-DOCK-SAM54CD2U
GDS® Tough-Dock™ + Dual USB for Samsung Tab Active4 Pro & Tab Active Pro

RAM-DIS-103-2AU
RAM® Standard Heavy Duty Accessory/Display Bracket

RAM-KB2-USB
GDS® Keyboard™ with Track Pad

RAM-101U
RAM® Double Ball Mount with Two Round Plates - C Size Medium

BUNDLES

How to Build a Vehicle Bundle

The combination of the industry standard RAM® Mounts and GDS® Ecosystem™ enables an efficient workflow for on-the-go professionals. No matter the device you're deploying, explore these turnkey vehicle solutions that industry experts rely on to keep their devices protected, connected, and charged.



WHAT'S INCLUDED

INTELLISKIN®

RAM-GDS-SKIN-SAM83-NG

IntelliSkin® Next Gen for Samsung Tab A8 10.5"

GDS® DOCK

RAM-GDS-DOCKL-SAM83CPU

Locking GDS® Tough-Dock™ with USB Type-C for Samsung Tab A8 10.5"

RAM® MOUNT

RAM-101-B-225B2U

RAM® Drill-Down Dashboard Mount with Backing Plate - C Size Short

RAM® CHARGER

RAM-GDS-CHARGE-V3C-2U

GDS® Modular 10-30V Power Delivery Hardwire Charger with Male USB Type-C

Samsung
Tab A8 10.5"

[CLICK TO SHOP](#)



RAM® VEHICLE BUNDLES



Apple
iPad 10th Gen

[CLICK TO SHOP](#)



Apple
iPad Pro 12.9 3rd-6th Gen

[CLICK TO SHOP](#)



Apple
iPad Mini 6

[CLICK TO SHOP](#)



Apple
iPad Air 4 & 5 and iPad Pro 11" 1st-4th Gen

[CLICK TO SHOP](#)



Samsung
Tab Active4 Pro

[CLICK TO SHOP](#)



Samsung
Tab Active3

[CLICK TO SHOP](#)



Zebra
ET4x 8" Tablet

[CLICK TO SHOP](#)



Samsung
Tab S8+, S7+ & S7 FE 12.4"

[CLICK TO SHOP](#)



Samsung
Tab S7 11"

[CLICK TO SHOP](#)



SEE PAGE 53 FOR COMPATIBLE DOCKS

Patented and Pats. Pend. rammount.com/ip gdstech.com

BUNDLES

Building a Forklift Bundle

By leveraging GDS® Reach™ enabled by the GDS® Ecosystem™, warehouses can set the framework for standardization and improve their overall workflow. From forklifts to pick carts, RAM® Mounts and GDS® Tech™ experts have crafted an assortment of end-to-end solutions that can be easily integrated with your current devices or during your next device deployment.

Option B With Keyboard

For workers needing to input data on-the-go, opt for the forklift bundle featuring this keyboard-ready mounting solution.

Note: You have to select a GDS® Dock with peripheral support in order for keyboard connection to work

Option A No Keyboard

Rely on your device's capabilities and streamline your workflow with this no-frills forklift solution.

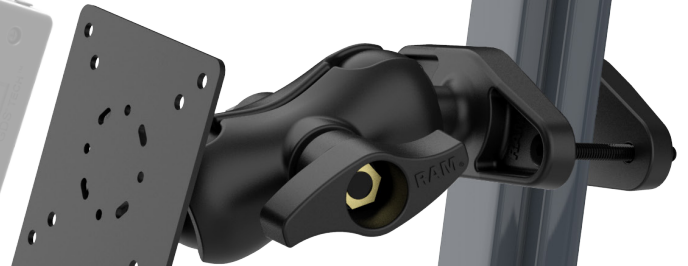

RAM-KB2-USB
GDS® Keyboard™ with Track Pad

RAM-101U
RAM® Double Ball Mount with Two Round Plates - C Size Medium

RAM-101U-247-4
RAM® 4" Square Post Clamp Mount with Round AMPS Plate - C Size

RAM-D-101U-C-247-4
RAM® 4" Square Post Clamp Mount with Round AMPS Plate - D

RAM-DIS-103-2AU
RAM® Standard Heavy Duty Accessory/Display Bracket

BUNDLES

Upgrading your Laptop Mount to GDS®

RAM® Mounts and GDS® Tech™ are designed with modularity in mind to provide a futureproof solution. When the time comes to upgrade your existing laptop mount, follow steps outlined by our product experts and explore the GDS® Tech™ accessories available.



Option A
Recreate a Desktop Experience

Maintain office efficiency from the comfort of your vehicle with solutions designed to accommodate input devices, like the GDS® Keyboard™.

RAM-VP-SW2F-89

RAM® Tele-Pole™ with 8" & 9" Poles and Double Ball Mount

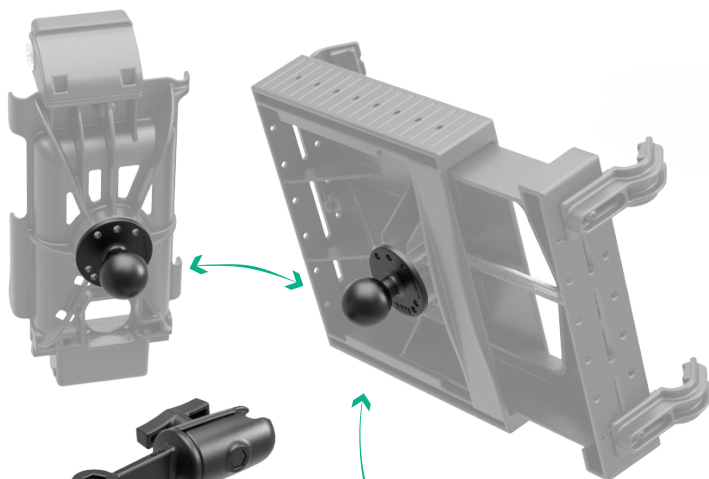

Option B
Swap Your Devices

From Landscape to Portrait, RAM® Mounts features 360-degree adjustability for the ideal viewing angle.

RAM-202U

RAM® Round Plate with Ball - C Size



FUTUREPROOFING

Modular Components

The modularity of GDS® docks provide the highest quality and most cost-effective solutions for tablets, including inevitable future device upgrades. With interchangeable dock latch and bases, it's easy to modify existing mounting systems without breaking the bank on an entirely new system.

RAM-GDS-DOCK-V10C-CU
 GDS® Power + USB-C Data
 Dock Cup for IntelliSkin®
 Next Gen Tablets



TOP CUPS



RAM-GDS-DOCKHU
 GDS® Tough-Dock™ & Cool-Dock™
 Top Latch



RAM-GDS-DOCKLH2U
 GDS® Tough-Dock™ & Cool-Dock™
 Locking Top Latch

BOTTOM CUPS	POWER CONNECTOR	PERIPHERAL PORTS
RAM-GDS-DOCK-V10PU	USB Type-C 2.0	—
RAM-GDS-DOCK-V10PDU	USB Type-C 2.0	USB Type-A
RAM-GDS-DOCK-V10PD2U	USB Type-C 2.0	Dual USB Type-A
RAM-GDS-DOCK-V10C-CU	USB Type-C 2.0	USB Type-C
RAM-GDS-DOCK-V10C-CAU	USB Type-C 2.0	USB Type-C USB Type-A
RAM-GDS-DOCK-V10C-R45AU	USB Type-C 2.0	RJ45 USB Type-A

FUTUREPROOFING

Input Devices

GDS® Tech bases support peripheral enablement and allow users to connect up to two Type-A peripherals directly to their device. With a variety of accessories available in the GDS® Ecosystem™, you can easily swap as the needs of your company grow.

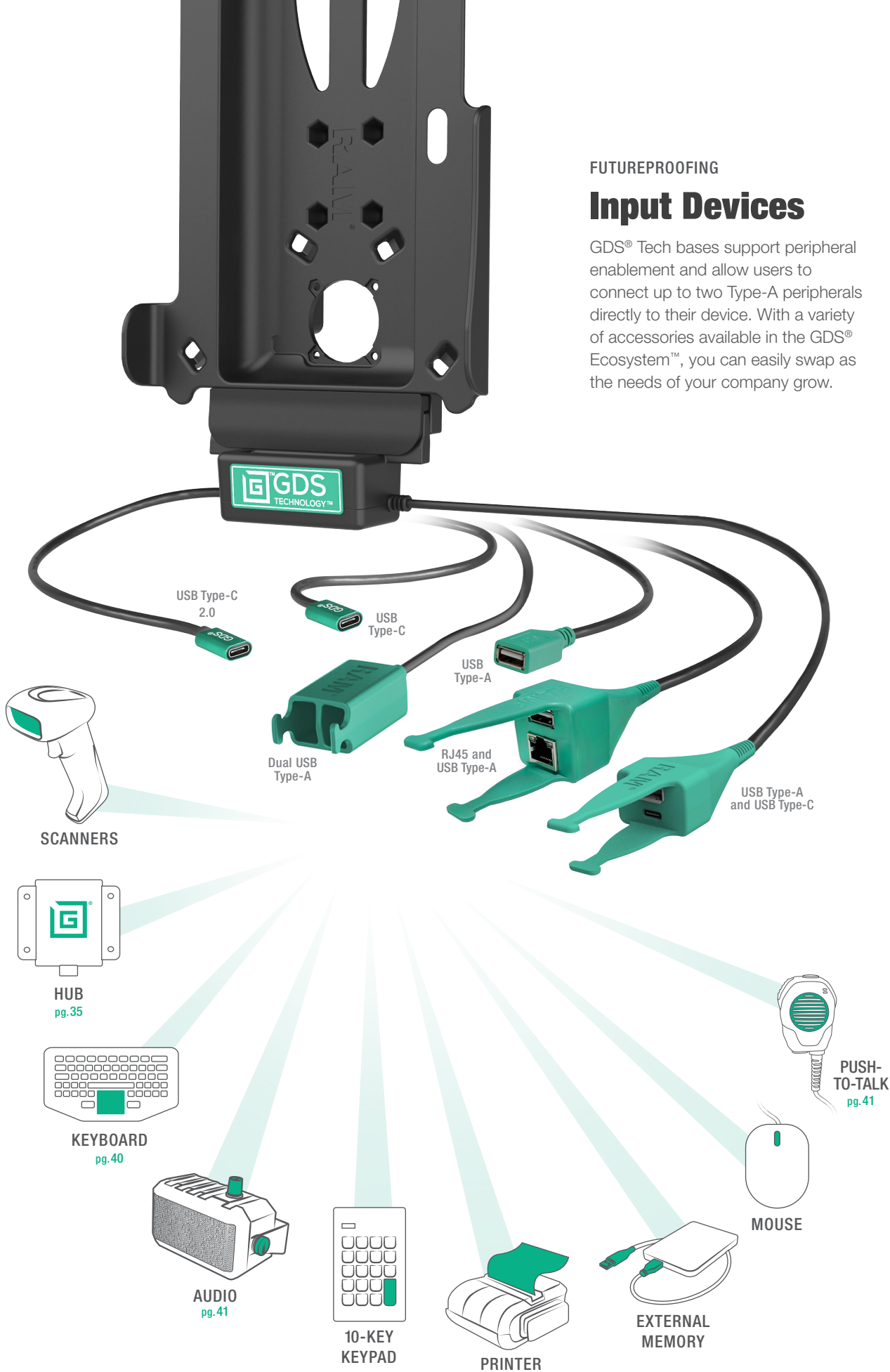

SEEN IN THIS PHOTO:

RAM-GDS-DOCK-V11CU
GDS® Vehicle Dock with USB
Type-C for IntelliSkin® Products



SEEN IN THIS PHOTO:

RAM-GDS-SKIN-SAM84
IntelliSkin® for Samsung Galaxy
XCover6 Pro



PARTNER SOLUTIONS

Samsung XCover6 Pro

RAM® Mounts offers a variety of solutions for Samsung's newest rugged smartphones. Whether you're on the go or in the office, powered accessories are essential for keeping your XCover6 Pro charged and connected. Protect your investment and improve your workflow with enterprise-ready solutions utilizing IntelliSkin® and GDS® Technology™.

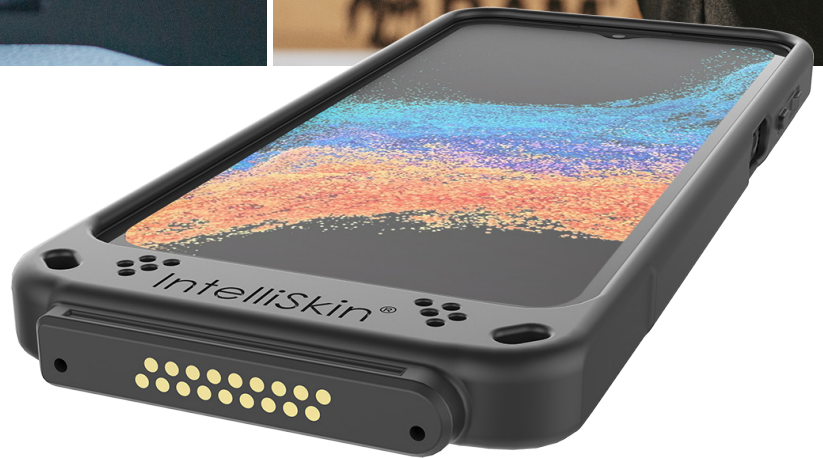

RAM-GDS-SKIN-SAM84
IntelliSkin® for Samsung Galaxy XCover6 Pro

INTELLISKIN FEATURES



Military-grade drop protection to withstand shock and impact

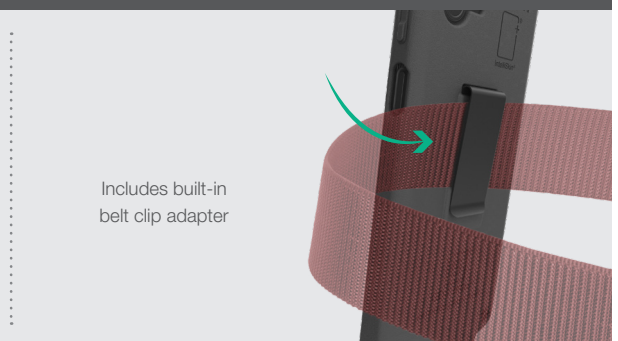

Includes built-in belt clip adapter

COMPATIBLE GDS® DOCKS™



RAM-GDS-DOCK-D7AU
GDS® Desktop Dock with Power Delivery & Peripheral Port



RAM-GDS-DOCK-6G1PD-NGU
GDS® 6-Port Power Delivery Desktop Charger for IntelliSkin® Next Gen



RAM-GDS-DOCK-D7U
GDS® Desktop Dock with Power Delivery



RAM-GDS-DOCK-V3CPAU
GDS® Vehicle Dock for Samsung XCover6 Pro with IntelliSkin®

Not compatible with hand strap accessories

Compatible with hand strap accessories



RAM-GDS-DOCK-V11CU
GDS® Vehicle Dock with USB Type-C for IntelliSkin® Products



RAM-GDS-HS4U
GDS® Hand Strap for XCover6 Pro with IntelliSkin® or RAM® Skin™



RAM-GDS-HS4MU
GDS® Magnetic Hand Strap for XCover6 Pro with IntelliSkin® or RAM® Skin™

PARTNER SOLUTIONS

GDS® Tech™ for Zebra Handheld Computers

Device Protection + Up to 30% Faster Charging

Keep the same benefits of GDS® Tech™ and IntelliSkin® for tablets, enabled for handhelds. Protect your EC50/EC55 and its charging port by wrapping in an IntelliSkin® protective sleeve. This sleeve enables a seamless docking experience by instantly connecting the device to a charging source while docked in a GDS® vehicle or desktop docking station. The GDS® and IntelliSkin® ecosystem installs a turnkey solution to your enterprise, improving the workflow of your warehouse and setting the framework for standardization.



Available IntelliSkin®

NEW 	NEW 	NEW 	NEW 
RAM-GDS-SKIN-ZE16-NG IntelliSkin® for EC50/EC55	RAM-GDS-SKIN-ZE34 IntelliSkin® for TC53/TC58	RAM-GDS-SKIN-ZE35 IntelliSkin® for TC73/TC78	RAM-GDS-SKIN-ZE24 IntelliSkin® for TC22/TC27

GDS® Desktop Docks

NEW 	NEW 
RAM-GDS-DOCK-6G15P GDS® 6-Port Charging Dock for Zebra Handheld PCs with IntelliSkin®	RAM-GDS-DOCK-6G15P-RJ45 GDS® 6-Port Charging Dock with RJ45 Ports for Zebra Handheld PCs with IntelliSkin®



Modular top cup for other device fitment

Key-locking option for theft deterrence

Heated pogo pin option prevents locking up, allowing operation in wet, freezing environments

Additional USB-A connector option for peripheral support



NEW



RAM-GDS-DOCK-V12-ZE16CPU
GDS® Handheld PC Dock for EC50/EC55

NEW



RAM-GDS-DOCK-V12-ZE2434CPU
GDS® Handheld PC Dock for TC22/27 and TC53/TC58

NEW



RAM-GDS-DOCK-V12-ZE35CPU
GDS® Handheld PC Dock for TC73/TC78

All GDS® Handheld PC Docks with USB Type-C

PART NUMBER	Device	Key Lock	Peripheral Support	Heated Pogo Pin	USB-C 3.0 With Video
RAM-GDS-DOCKL-V12-ZE16CPU	EC50 & EC55	•	Available	Available	Available
RAM-GDS-DOCK-V12-ZE16CPU	EC50 & EC55		Available	Available	Available
RAM-GDS-DOCKL-V12-ZE2434CPU	TC22, TC27, TC53, & TC58	•	Available	Available	Available
RAM-GDS-DOCK-V12-ZE2434CPU	TC22, TC27, TC53, & TC58		Available	Available	Available
RAM-GDS-DOCKL-V12-ZE35CPU	TC73 & TC78	•	Available	Available	Available
RAM-GDS-DOCK-V12-ZE35CPU	TC73 & TC78		Available	Available	Available

IntelliSkin® with GDS® Technology™ for Zebra ET40/ET45 8" & 10"

Wrap your new Zebra ET40 or ET45 in an IntelliSkin® protective sleeve to unlock all the features and benefits of the GDS® Ecosystem™. By sliding your tablet into an IntelliSkin®, an integrated USB connector converts power and data sync through pogo pad contacts. These contacts align directly to the pogo pins on all GDS® Docks™ for a seamless GDS® Reach™ experience with charged and added capabilities of peripherals such as a keyboard, scanner, printer, and more.



RAM-GDS-SKIN-ZE20C-NG
IntelliSkin® Next Gen for
Zebra ET4x 8" Enterprise Tablet



RAM-GDS-SKIN-ZE21C-NG
IntelliSkin® Next Gen for
Zebra ET4x 10" Enterprise Tablet



RAM-GDS-DOCK-ZE20PU
GDS® Powered Dock for
Zebra ET4x 8" Tablet with IntelliSkin®

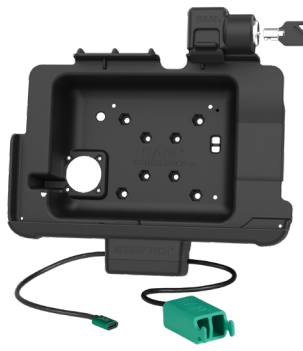

RAM-GDS-DOCKL-ZE20PD2U
Locking GDS® Power + Dual USB Dock
for IntelliSkin®



RAM-GDS-DOCKNLL-ZE20PU
GDS® Powered Dock with Latch
for Zebra ET4x 10" Tablet with IntelliSkin®



SEEN IN THIS PHOTO:

RAM-GDS-SKIN-ZE21C-NG
IntelliSkin® Next Gen for Zebra
ET4x 10" Enterprise Tablet

RAM-GDS-DOCKL-ZE21PDU
Locking GDS® Power + Data Dock
for Zebra ET4x 10" with IntelliSkin®

RAM-DIS-103-2AU
RAM® Standard Heavy Duty
Accessory/Display Bracket

RAM-101U
RAM® Double Ball Mount with Two
Round Plates - C Size Medium

RAM-KB2-USB
GDS® Keyboard™ with Track Pad

PARTNER SOLUTIONS

GDS® Dock™ Solutions for Zebra ET40/ET45 8" & 10"

Ruggedizing everyday tasks like inventory management, proof of pickup and delivery, or mobile point of sale just became easier. With GDS® Tech™ docking solutions and IntelliSkin® case system, Zebra's new ET40 & ET45 rugged tablets can stay connected and protected. These docks and skins come with pogo pin technology to keep your device connected to power and have the ability to add peripherals while protecting the device's ports. This standardized connectivity unlocks the GDS® Reach™ experience, enabling a seamless workflow.



RAM-GDS-DOCKL-ZE20PD2U
Locking GDS® Power + Dual USB Dock for Zebra ET4x 8" with IntelliSkin®



RAM-GDS-DOCKL-ZE21PD2U
Locking GDS® Power + Dual USB Dock for Zebra ET4x 10" with IntelliSkin®

PART NUMBER	Powered	Key Lock	Single USB Peripheral	Dual USB Peripheral	ET40/ET45 8"	ET40/ET45 10"
RAM-GDS-DOCK-ZE20PU	•				•	
RAM-GDS-DOCK-ZE20PDU	•		•		•	
RAM-GDS-DOCK-ZE20PD2U	•			•	•	
RAM-GDS-DOCKL-ZE20PU	•	•			•	
RAM-GDS-DOCKL-ZE20PDU	•	•	•		•	
RAM-GDS-DOCKL-ZE20PD2U	•	•		•	•	
RAM-GDS-DOCK-ZE21PU	•					•
RAM-GDS-DOCK-ZE21PDU	•		•			•
RAM-GDS-DOCK-ZE21PD2U	•			•		•
RAM-GDS-DOCKL-ZE21PU	•	•				•
RAM-GDS-DOCKL-ZE21PDU	•	•	•			•
RAM-GDS-DOCKL-ZE21PD2U	•	•		•		•

BEST SELLER



RAM-GDS-ROTO2-ZE20U
GDS® Roto-Mag™ 3-in-1 Grip Handle Accessory for Zebra ET4x 8" Tablet



RAM-GDS-ROTO2-ZE21U
GDS® Roto-Mag™ 3-in-1 Grip Handle Accessory for Zebra ET4x 10" Tablet



RAM-GDS-HS1-ZE21U
GDS® Hand-Stand™ for Zebra ET4x 10"



RAM-GDS-HS2-ZE21U
GDS® Hand Strap Accessory for Zebra ET4x 10"

PARTNER SOLUTIONS

GDS® Desktop Docks for Zebra ET40 and ET45

Wrap your new Zebra ET40 or ET45 in an IntelliSkin® Next Gen protective sleeve to unlock all the features and benefits of the GDS® Ecosystem™. By sliding your tablet into an IntelliSkin®, an integrated USB connector converts power and data sync through pogo pad contacts. These contacts align directly to the pogo pins on all GDS® Docks™ for a seamless charging experience with the added capabilities of peripherals such as a keyboard, scanner, printer, and more.

The range of the GDS® Ecosystem™ doesn't stop with vehicles. Desktop charging docks are also available with both single and multi-port options. Not only can these desktop docks charge your devices up to 30% faster than traditional charging, but they also have device mirroring and ethernet sync capabilities. All of this is possible with the combination of a ruggedized, connective product line and the patented pogo pin technology — we call this the GDS® Reach™.



SEEN IN THIS PHOTO:

RAM-GDS-DOCK-D7AU
GDS® Desktop Dock with Power Delivery & Peripheral Port



The distinctive "D" shape of the GDS® connector ensures proper docking alignment



RAM-GDS-DOCK-D7AU
GDS® Desktop Dock with Power Delivery & Peripheral Port

New GDS® Multi-Port Charging Docks

Charge up to six IntelliSkin®-wrapped Zebra ET40/ET45 tablets with these multi-port charging docks. Ditch the cords and consolidate your charging experience with this simple drop-in desktop dock with fast charging capabilities. An additional version of this dock comes equipped with RJ45 ports for pushing tablet updates and other data over an ethernet connection.

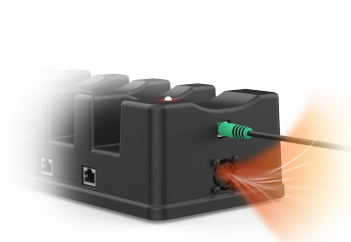
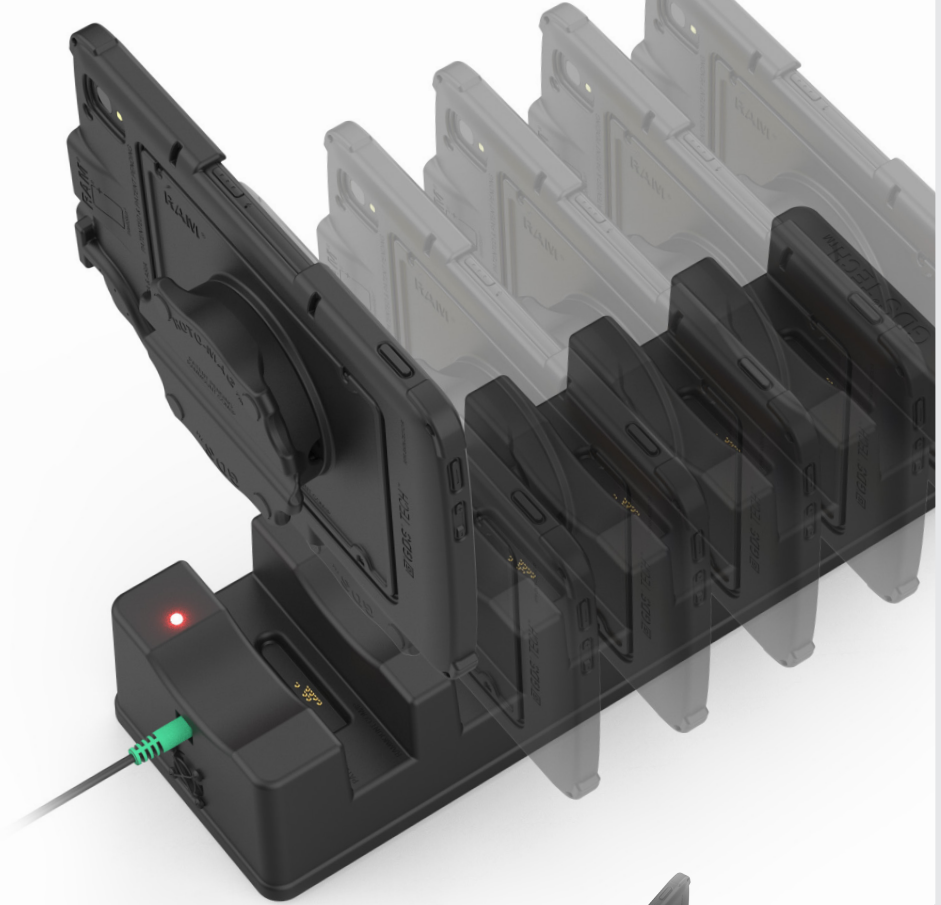

Built-in fan clears heat from the dock to prevent overheating

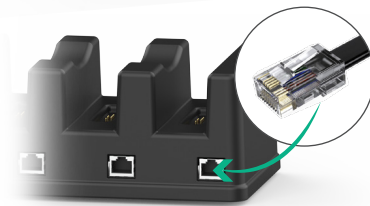

Dock option with RJ45 ports for pushing data over ethernet



Up to 30% Faster Charging

Multi-Port Charging Dock Options



RAM-GDS-DOCK-6G16P
GDS® 6-Port Charging Dock
for Zebra ET40/ET45 with IntelliSkin®



RAM-GDS-DOCK-6G16P-RJ45
GDS® 6-Port Charging Dock with RJ45 Ports
for Zebra ET40/ET45 with IntelliSkin®

ACCESSORIES & ADD-ONS

GDS® Ergo™

The RAM® Skin™ and IntelliSkin® product lines are compatible with a variety of GDS® Ergo™ accessories that enable your tablet for field use. Make traveling with your tablet more comfortable and efficient by pairing your device with the GDS® Hand-Stand™—this combination hand strap and kickstand accessory allows you to take your device from the warehouse to the office and everywhere in between. Take advantage of mounting your tablet to ferrous surfaces with the GDS® Roto-Mag™ and the magnetic version of the GDS® Hand-Stand™.

Designed with a comfortable fit for hands of all sizes in mind, the GDS® Hand-Strap includes compatibility for gloved hands. It also features a 360-degree rotation so users can adjust to their ideal viewing angle.



RAM-GDS-HS1MU

GDS® Hand-Stand™ Magnetic Hand Strap and Kickstand for Tablets

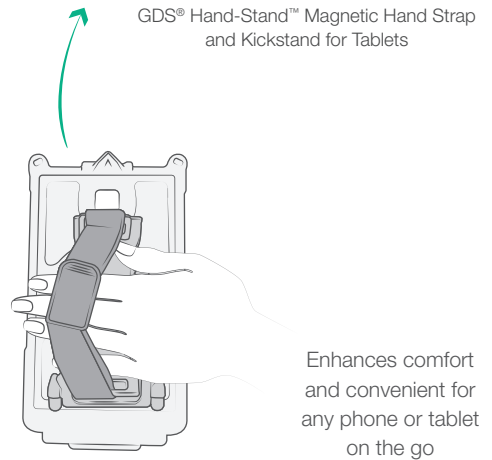

Enhances comfort and convenient for any phone or tablet on the go

PART NUMBER	DESCRIPTION
RAM-GDS-HS1U	GDS® Hand-Stand™
RAM-GDS-HS1MU	GDS® Hand-Stand™ with Magnetic Hand Strap
RAM-GDS-SS1U	GDS® Shoulder Strap Accessory
RAM-GDS-BRUSH-01U	IntelliSkin® Contact Brush
RAM-GDS-STU	GDS® Wrist Strap for IntelliSkin®

FEATURES

Magnet

Magnetic GDS® Hand-Stand™ connects to any ferrous surface

GDS® Hand-Stand™ compatible with most IntelliSkin® wrapped tablets

Shoulder strap compatible with most IntelliSkin® wrapped phones & tablets



SEEN IN THIS PHOTO:

RAM-GDS-SKIN-AP37-NG

IntelliSkin® Next Gen for Apple iPad Pro 12.9 3rd - 6th Gen

RAM-GDS-ROTO2U

GDS® Roto-Mag™ 3-in-1 Accessory with Grip Handle, Hand Strap & Magnets



Built-in LED

Select IntelliSkin® cases have a built-in LED option for those limited light situations when you need a flashlight in a pinch.

RAM-GDS-SKIN-SAM80-NG-LED

IntelliSkin® with LED Light for Samsung Tab A7 Lite 8.7"



Go Hands Free

The GDS® Hand-Stand™ Hand Strap with Kickstand works with all IntelliSkin® for an easy way to take advantage of workstation enablement.

RAM-GDS-HS1U

GDS® Hand-Stand™ Hand Strap and Kickstand for Tablets



RAM-GDS-SS1U

GDS® Shoulder Strap Accessory for IntelliSkin® Products

Cleans the GDS® contacts on the bottom of IntelliSkin® sleeves to prevent loss in functionality



RAM-GDS-BRUSH-01U

IntelliSkin® Contact Brush



RAM-GDS-STU

GDS® Wrist Strap for IntelliSkin®



RAM-GDS-HS1U

GDS® Hand-Stand™ Hand Strap and Kickstand



RAM-GDS-ROTO2U

GDS® Roto-Mag™ 3-in-1 Accessory



SEEN IN THIS PHOTO:

RAM-GDS-DOCKL-SAM62CPU

Locking GDS® Tough-Dock™ with USB Type-C for Tab Active3 & 2

RAM-VENT1-RCT-50U

RAM® Vent-Temp™ with Back Dock Connection for Rectangular Vents

[WATCH VIDEO](#)



SEEN IN THIS PHOTO:

RAM-HOL-ZE21PDU

RAM® Power + Dual USB Locking Dock for Zebra ET4x 10"

RAM-VENT1-RND-50U

RAM® Vent-Temp™ with Back Dock Connection for Round Vents



Temperature Control Products

Located at the back of your dock is an empty housing for upgrading your mounting solution. This housing can accommodate various temperature modules provided by RAM® Mounts. Easily install either the RAM® Vent-Temp™, which connects to your vehicle's vents or the RAM® Temp-Right™, which provides regulated heat in extremely cold environments.



RAM® Vent-Temp™ Back Nozzle Attachment

Hot or cold air from your vehicle's air system enters through the RAM® Temp-Right™ nozzle, travels through flexible tube, and exits behind the docked tablet.

RAM-VENT1-RCT-50U

RAM® Vent-Temp™ with Back Dock
Connection for Rectangular Vents

RAM-VENT1-RND-50U

RAM® Vent-Temp™ with Back Dock
Connection for Round Vents

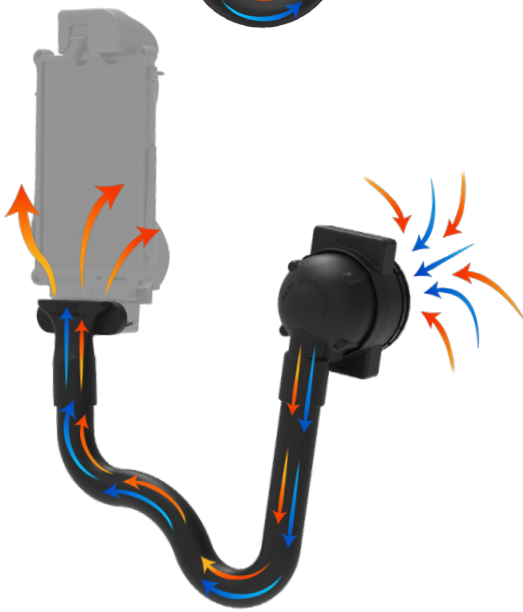

RAM® Vent-Temp™ Front Nozzle Attachment

Hot or cold air from your vehicle's air system enters through the RAM® Temp-Right™ nozzle, travels through flexible tube, and exits in front of the docked tablet.

RAM-VENT2-RCT-50U

RAM® Vent-Temp™ with Front Dock
Connection for Rectangular Vents

RAM-VENT2-RND-50U

RAM® Vent-Temp™ with Front Dock
Connection for Round Vents

FEATURES

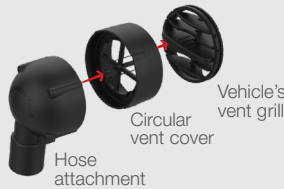

Vent cover attaches directly to circular vents using zip ties

Hose attachment includes built-in magnets for easy break-away when not in-use



RAM® Temp-Right™

The RAM® Temp-Right™ heater module regulates device temperatures to maintain functionality in extreme cold environments. Cabin air gets drawn through the Temp-Right™ fan and through the module, heating the air up to the right temperature needed for tablet functionality.

RAM-DOCK-HEATER1-BU

RAM® Temp-Right™ Dock Heating
Module for GDS® Tough-Dock™



SEEN IN THESE PHOTOS:

RAM-GDS-DOCKL-SAM62CP-NFCU

Locking GDS® Tough-Dock™ for Tab Active3 with RAM® NFC Extender

RAM-101-225B2U

RAM® Drill-Down Dashboard Mount with Backing Plate - C Size Medium



NFC ATTACHMENT METHODS

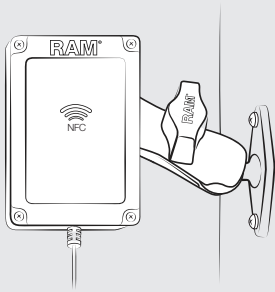

Double Ball Mount: Flat Surface

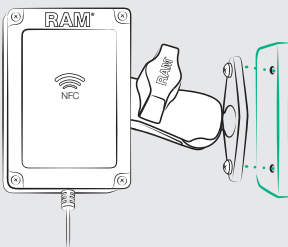

Double Ball Mount: Direct to Dock

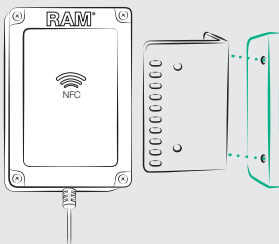

Direct to Dock: 90° Bracket

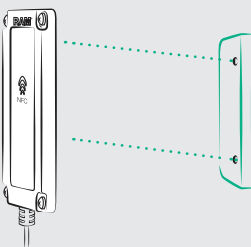

Direct to Dock: Low-Profile

ACCESSORIES & ADD-ONS

RAM® NFC Extender

RAM® Mounts takes NFC scanning to the next level with the brand new RAM® NFC Extender by adding an NFC repeater to your NFC capable tablet. With this NFC repeater, tablet operators no longer need to remove the device from its docking station to scan—simply install the repeater on your docking station and give easy access to programs like Tap To Pay, asset tracking, time management, and more.

Choose from four mounting options for the NFC Repeater

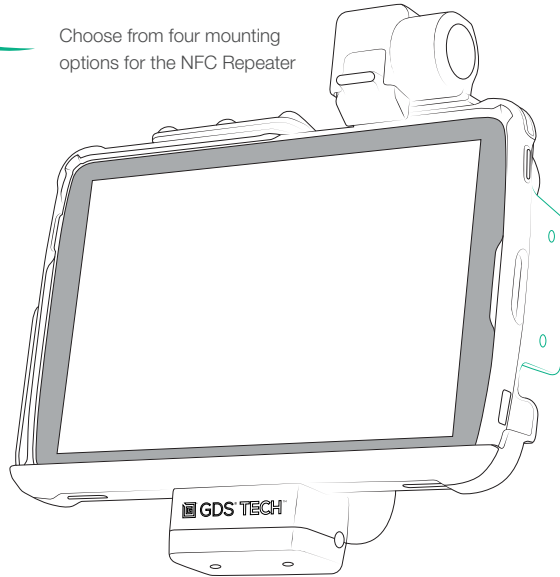

RAM-GDS-DOCKL-SAM62CP-NFCU
Locking GDS® Tough-Dock™ for Tab Active3 with RAM® NFC Extender



RAM-GDS-DOCK-SAM62CP-NFC
GDS® Tough-Dock™ for Tab Active3 with RAM® NFC Extender



RAM-GDS-DOCKB-SAM62-NFCU
GDS® Tough-Dock™ Body for Samsung Tab Active3 with NFC Extender



SEEN IN THIS PHOTO:

RAM-GDS-SKIN-SAM54-NG-1
IntelliSkin® Next Gen for Samsung Tab Active4 Pro & Tab Active Pro

RAM-GDS-DOCKL-V9-OMT1U
GDS® Type-C Vehicle Dock for IntelliSkin® Next Gen Tablets

RAM-VB-195-SW2
RAM® No-Drill™ Mount for '17-21 Ford F-250 - F-550 + More

UNIVERSAL DOCKS

Tab-Lock™ Docks for IntelliSkin®

GDS® Reach™ enables GDS vehicle docks as a universal charging platform for any device wrapped in an IntelliSkin® sleeve. IntelliSkin® offers drop protection and uses ruggedized external contacts to allow for repetitive docking, with no need to deal with charging cables.

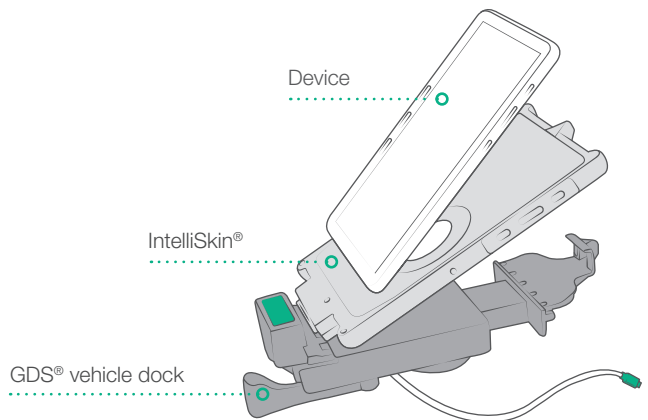

PART NUMBER	CASE IntelliSkin Next Gen	POWER Power Delivery
RAM-GDS-DOCKL-V9-SAM67CU	Samsung Tab A 8.0 (2019) Samung Tab A 8.4	USB Type-C 3.1
RAM-GDS-DOCKL-V10-SAM67CPU	Samsung Tab A 8.0 (2019) Samung Tab A 8.4	USB Type-C 2.0
RAM-GDS-DOCKL-V10-OMT1U	Universal	USB Type-C 2.0
RAM-GDS-DOCKL-V9-OMT1U	Universal	USB Type-C 3.1



BEST SELLER

RAM-GDS-DOCKL-V9-OMT1U
 USB Type-C + Data Sync

FEATURES

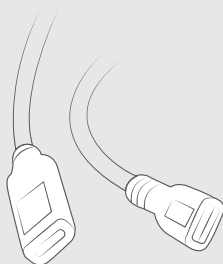

USB Type-C docks provide fast charging

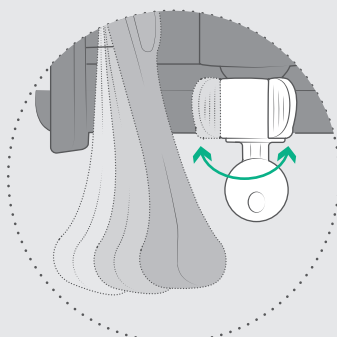

Key locking

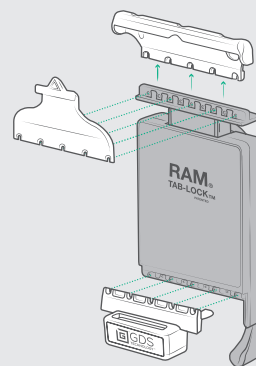

Interchangeable docking cups



SEEN IN THIS PHOTO:

RAM-GDS-DOCKL-V3CU

GDS® Locking Vehicle Phone Dock with USB Type-C for IntelliSkin®

RAM-GDS-SKIN-SAM59

IntelliSkin® for Samsung Galaxy XCover Pro

RAM-B-103-238U

RAM® Double Socket Arm with Diamond Plate

RAM-B-202U

RAM® Round Plate with Ball - B Size

FEATURES



The integrated GDS® Technology™ platform enables charging of the mounted device and safely secures the phone in a variety of vibration applications

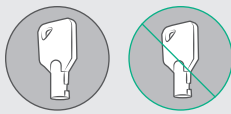

Locking & non-locking options available

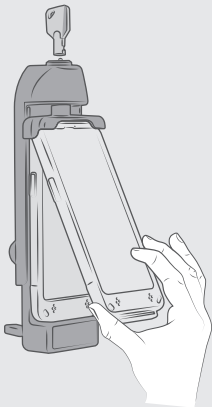

One-handed operation to secure your IntelliSkin®-wrapped phone

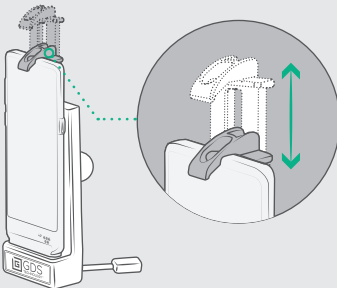

Spring loaded, quick release cradle that offers a secure fit with easy access to the mounted phone or phablet

UNIVERSAL DOCKS

GDS® Vehicle Phone and Handheld PC Docks

GDS® phone docks contain the same integrated pogo pin technology as GDS® Docks™ for tablets to support device charging while docked, as well as data transfer capabilities. Keep all of your files stored on your IntelliSkin®-wrapped smartphone and transfer to a desktop dock to upload to your computer—no additional cords or data storage devices necessary. Depending on your application, these IntelliSkin® phone docks are available with multiple options to choose from including locking, non-locking, and USB Type-C connections.



RAM-GDS-DOCKL-V3CU
GDS® Locking Vehicle Phone Dock with USB Type-C 3.1 for IntelliSkin®

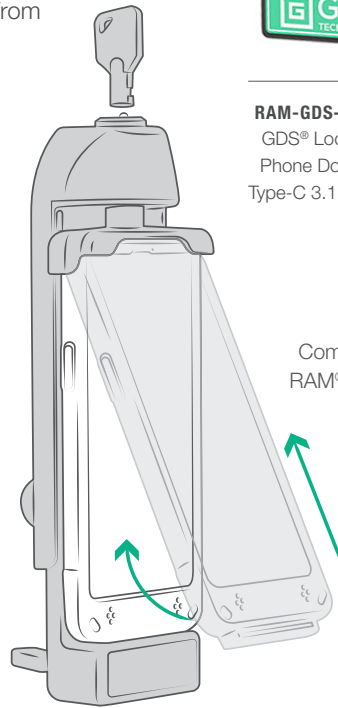

Compatible with all RAM® B size mounts



RAM-GDS-DOCK-V11CU
GDS® Handheld PC Dock with USB Type-C 3.1 for IntelliSkin® Products



RAM-GDS-DOCK-V1CPU
GDS® Vehicle Phone Dock with USB Type-C 2.0 for IntelliSkin® Products



RAM-GDS-DOCK-V1CU
GDS® Vehicle Phone Dock with USB Type-C 3.1 for IntelliSkin® Products

UNIVERSAL DOCKS

GDS® Desktop Docks

Perfect for office environments, GDS® desktop docks can support any device equipped with an IntelliSkin® sleeve to deliver full-time charging as well as data transfer capabilities. Docks ranging from single to multi-device support keep electronic devices protected and at the ready. GDS® desktop docks support a number of electronic devices as well as power and data communication.



RAM-GDS-DOCK-D7U
GDS® Desktop Dock with Power Delivery



RAM-GDS-DOCK-D7AU
GDS® Desktop Dock with Power Delivery & Peripheral Port



Provides scalability as mobile electronics evolve. Enabling users to minimize expense for future electronics by its modular design and easy upgrades.

GDS® DOCK	CASE IntelliSkin Next Gen	CASE Phone & Legacy IntelliSkin	POWER Power Delivery	DATA USB Type-A Cable	PERIPHERAL SUPPORT Single	COMPATIBILITY Samsung DeX
RAM-GDS-DOCK-D7U	•	•	•			
RAM-GDS-DOCK-D7AU	•	•	•		•	
RAM-GDS-DOCK-D2CM-NDU	•		•			•
RAM-GDS-DOCK-D2C-NDU	•			•		
RAM-GDS-DOCK-D2CMU		•	•			
RAM-GDS-DOCK-D2U		•		•		

FEATURES

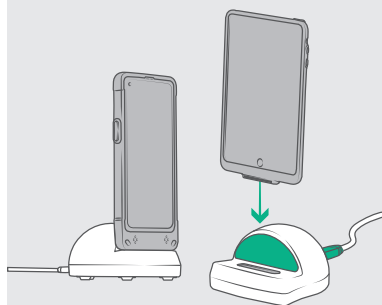

Low-profile docking station for electronic devices equipped with an IntelliSkin® protective case

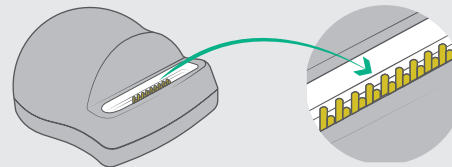

The Desktop Dock features pogo pin contacts designed to match the pogo pads on IntelliSkin®-wrapped devices supporting USB Type-C data transfer and charging profiles

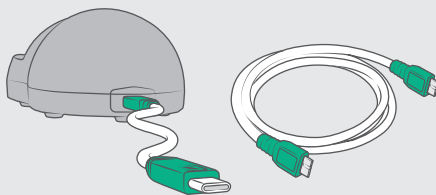

Power Delivery docks include a male to male USB Type-C cord which plugs directly into the back of the dock and to a Power Delivery charging source, or external hub

UNIVERSAL DOCKS

6-Port Charging Docks

The RAM® 6-Port Charging Dock was designed specifically to support up to six devices for simultaneous charging. These charging stations reduce the amount of charging cords needed to charge each device by consolidating power through one cord and provide each electronic device with its own charging bay to reduce clutter.

Additional Features

- 1 Supports devices that require power delivery
- 2 Steel weighted base with rubber pads creates strong hold on desktop
- 3 Integrated pogo-pins and distinctive D shape for all Intelliskins, Next Gen and legacy
- 4 6-Port Dock allows space for ergonomic accessories



RAM-GDS-DOCK-6G1PD-NGU
 GDS® 6-Port Power Delivery Desktop
 Charger for IntelliSkin® Next Gen

6-PORT CHARGING DOCKS	CASE IntelliSkin Next Gen	POWER Power Delivery	DATA Devices with Lightning Connector or mUSB Ports
RAM-GDS-DOCK-6G1PD-NGU	•	•	Not Supported
RAM-GDS-DOCK-6G1P-NGU	•	Not Supported	•
RAM-GDS-DOCK-6G1PU	Not Supported	Not Supported	•

Multi-Port for Handhelds

Multi-port charging docks are available for phones and handhelds compatible with caseless phones with IntelliSkin®.



RAM-GDS-DOCK-6G9PU
 GDS® 6-Port Desktop Charger
 for Phones with IntelliSkin®

GDS® Tough-Hub™

With the GDS® Tough-Hub™, keep a wide range of devices, docks, and peripherals charged and connected in nearly any vehicle. Each GDS® Tough-Hub™ includes numerous ports—USB, HDMI, RJ45, and more.

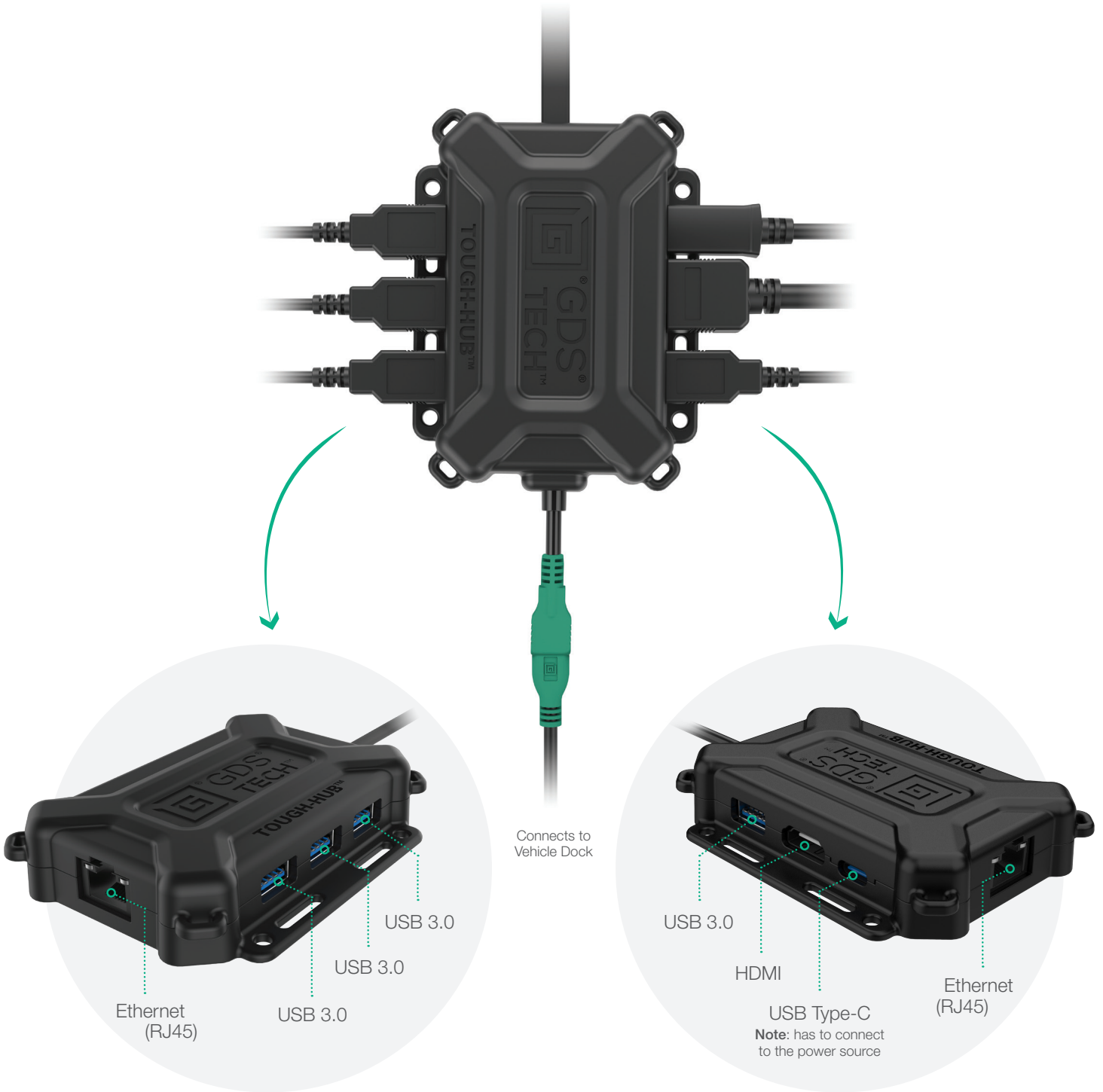

RAM-GDS-HUB-TYPEC-01

GDS® Tough-Hub™ with USB Type-C for Vehicles

SEEN IN THIS PHOTO:

RAM-GDS-DOCK-D2C-NDCU

GDS® Desktop Dock with USB Type-C for IntelliSkin® Next Gen (No Cable)

RAM-GDS-HUB-TYPEC-02-A

GDS® Hub™ With USB Type-C For Desktop

RAM-GDS-SKIN-SAM74-NG

IntelliSkin® Next Gen for Samsung Tab Active3



INPUT DEVICES

Desktop Experience On the Go

With Samsung DeX, you can transform your mobile device into a mobile office—from your vehicle to your desk. By connecting a Samsung DeX enabled device via USB to a GDS® Dock™, keep your device protected and charged while taking advantage of the desktop experience.

Includes a USB Type-C port to connect to the GDS® Hub™

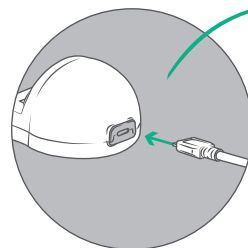

RAM-GDS-DOCK-D2C-NDCU

GDS® Desktop Dock with USB Type-C for IntelliSkin® Next Gen (No Cable)

FEATURES

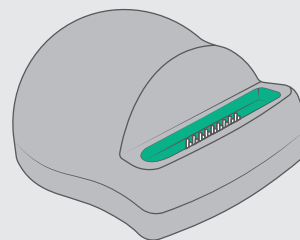
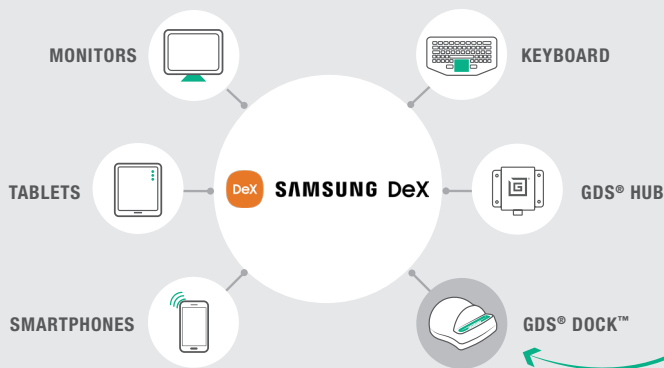

This desktop dock is also Samsung DeX compatible when using a DeX-compatible device wrapped in IntelliSkin®.



SEEN IN THIS PHOTO:

RAM-VB-196-GDS-EC01

GDS® Ecosystem™ Vehicle Bundle with Monitor, Keyboard & Phone Mount

RAM-HOL-TABL-KBU

RAM® Tab-Lock™ Locking Holder for GDS® Keyboard™

INPUT DEVICES

GDS® View™

The GDS® View™ 13.3" touchscreen monitor lets you take the PC experience on the road. Featuring VESA hole patterns compatible with the RAM-2461U and RAM-D-2461U mounting plates, create a mobile workstation that takes advantage of the GDS® Reach™ experience for data sync and charging capabilities. The GDS® View™ monitor has undergone MIL-STD-810H shock and vibration testing, ensuring performance in the most demanding environments.





This two-point capacitive touchscreen monitor allows you to pinch, zoom, and select—and includes an anti-glare and anti-fingerprint treatment. Control buttons on the front of the monitor are easy to access, while a red monochrome night mode helps to reduce eyestrain. In addition, two integrated 2W speakers allow for audio. Includes HDMI, VGA, and USB Type-B to USB Type-A cables.

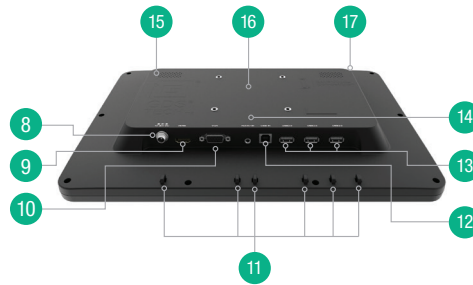
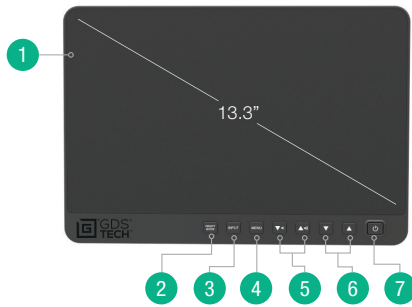

RAM-GDS-MON-13-1
GDS® View™ 13.3"
Touch Screen Monitor



FEATURES

1 Ambient Light Sensor	10 VGA 
2 Night Mode (On/Off)	11 Cable Tie-Downs
3 Input Selection (HDMI, PC)	12 USB Type-B 
4 Menu (on screen display)	13 USB Type-A 
5 Volume Up/Down (or navigate in menu)	14 Audio In 
6 Volume Up/Down (or navigate in menu)	15 Speaker (Left)
7 Power (ON/OFF)	16 VESA 75 Mounting (#10-24 Thread)
8 Power  (10-30V DC)	17 Speaker (Right)
9 HDMI 	

RAM-VB-196-GDS-EC01

GDS® Ecosystem™ Vehicle Bundle with Monitor, Keyboard & Phone Mount

- RAM-GDS-DOCK-V1CU**
GDS® Vehicle Phone Dock for phones with IntelliSkin®
- RAM-KB2-USB**
GDS® Keyboard™ available with and without trackpad
- RAM-HOL-TABL-KBU**
RAM® Tab-Lock™ Locking Holder for GDS® Keyboard™

RAM-VP-SW2F-45-2461
RAM® Tele-Pole™ with 4" & 5" Poles and Double Ball 75x75mm VESA Mount

RAM-VB-202-A-SW1
RAM® No-Drill™ Laptop Mount for Ford Explorer, Ranger & Bronco

GDS® ECOSYSTEM™
BUNDLES
FUTUREPROOFING
PARTNER SOLUTIONS
ACCESSORIES & ADD-ONS
UNIVERSAL DOCKS
INPUT DEVICES
CHARGING
COMPATIBILITY

SEEN IN THIS PHOTO:

RAM-GDS-SKIN-ZE21C-NG
IntelliSkin® Next Gen for Zebra
ET4x 10" Enterprise Tablet

RAM-GDS-DOCKL-ZE21PDU
Locking GDS® Power + Data
Dock for Zebra ET4x 10"
with IntelliSkin®

RAM-DIS-103-2AU
RAM® Standard Heavy Duty
Accessory/Display Bracket

RAM-101U
RAM® Double Ball Mount
with Two Round Plates - C
Size Medium

RAM-KB2-USB
GDS® Keyboard™ with
Track Pad



INPUT DEVICES

GDS® Keyboard™

Featuring AMPS and VESA hole patterns for attachment to a variety of brackets, these rugged GDS® Keyboard™ solutions are RAM® Mounts Compatible™. With the RAM® Tab-Tite™ and RAM® Tab-Lock™ holders, easily secure either wired keyboard into place for use in vehicles and other mobile workstations. Choose between two keyboard versions: one featuring a 10-key numeric pad and the other featuring a track pad.

BEST SELLER



RAM-KB2-USB
 GDS® Keyboard™ with Track Pad

Back view with AMPS & VESA hole patterns for any RAM® Mount

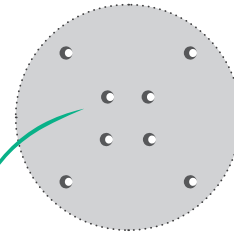

RAM-KB4-USB
 GDS® Keyboard™ with 10-Key Numeric Pad



RAM-DIS-103-1AU
 RAM® Standard Heavy Duty Accessory/Display Bracket



RAM-DIS-103-2AU
 RAM® Standard Heavy Duty Accessory/Display Bracket



RAM-HOL-TABL-KBU
 RAM® Tab-Lock™ Locking Holder for GDS® Keyboard™



RAM-HOL-TAB-KBU
 RAM® Tab-Tite™ Holder for GDS® Keyboard™

FEATURES



Track pad & 10-Key options available

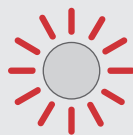

Backlit with red illumination to reduce eyestrain at night



IP65 rated to protect against dust and spills

INPUT DEVICES

GDS® Audio™

This amplified wired speaker can be efficiently adjusted to an ideal position, and includes a knob to quickly change the volume. The speaker is RAM® Mounts Compatible™—making it easy to secure wherever it's needed.



RAM-SPEAK-A01
GDS® Audio™ Amplified Speaker

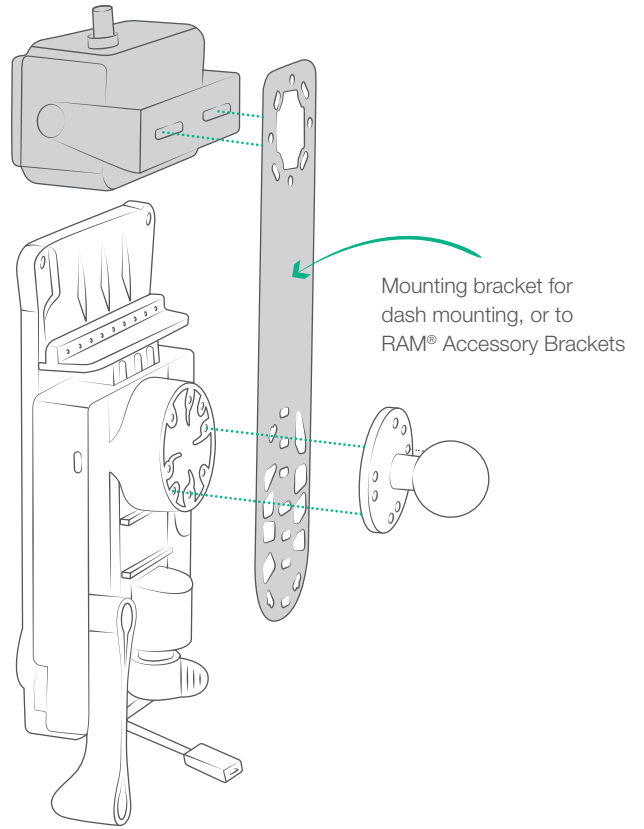

SEEN IN THIS PHOTO

RAM-SPEAK-A02
GDS® Audio™ Amplified Speaker with PTT Breakout Feature

RAM-GDS-DOCKL-V10-SAM67CPU
GDS® Type-C Powered Vehicle Dock for Samsung Tab A 8.4 & 8.0

RAM-101-MIC1U
RAM® Short Bracket Adapter for Speakers & Microphones



PUSH-TO-TALK

Unveiling the latest addition to the GDS® Ecosystem™ — compatible dock solutions for push-to-talk radios. Keep your on-the-go workers nimble and protect your devices' ports with the GDS® Tough-Dock™ + USB-C paired with the Klein Remote Speaker Microphone.

Compatible software providers include:

ES Chat, Zello, Tassta, Motorola, Airbus Tactilon Agent, Microsoft Teams Walkie Talkie (certified partner/certified headsets), Unity Intercom, AT&T: EPTT, T-Mobile: Direct Connect



USB-C peripheral connection for reliable communication between device and remote speaker mic

RAM-GDS-DOCK-SAM62C-CU

GDS® Tough-Dock™ + USB-C Data for Samsung Tab Active3

SEEN IN THIS PHOTO

RAM-GDS-DOCK-G7M-8-NG

GDS® Slide Dock™ with Power
Delivery & Magnetic Base



CHARGING

GDS® Slide Dock™

Designed to solve charging issues in a variety of applications, the GDS® Slide Dock™ is a scalable solution for charging multiple devices at the same time. It can be integrated into any flat surface, charging carts, and more. Each GDS® Slide Dock™ includes an LED indicator light that lets you know whether or not it's connected to power, and is available as both a drill-down attachment or a magnetic base.



RAM-GDS-DOCK-G7M-NGU
 GDS® Slide Dock™ with Magnetic Attachment

PART NUMBER	MOUNT TYPE	POWER CONNECTOR
RAM-GDS-DOCK-G7B-8-NGU	Drill-Down	USB Type-C Male
RAM-GDS-DOCK-G7M-8-NGU	Magnetic	USB Type-C Male
RAM-GDS-DOCK-G7-8-NGU	Module Only	USB Type-C Male
RAM-GDS-DOCK-G7B-NGU	Drill-Down	USB Type-A Male
RAM-GDS-DOCK-G7M-NGU	Magnetic	USB Type-A Male
RAM-GDS-DOCK-G7-NGU	Module Only	USB Type-A Male

FEATURES

The GDS® Slide Dock™ has a USB Type-C male output that can plug into an existing USB port on a cart

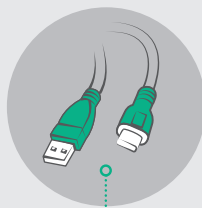

There is an LED indicator light that turns red when your dock is connected to power

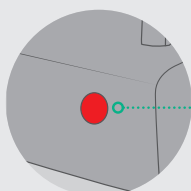

Adjustable height accommodates a variety of different devices

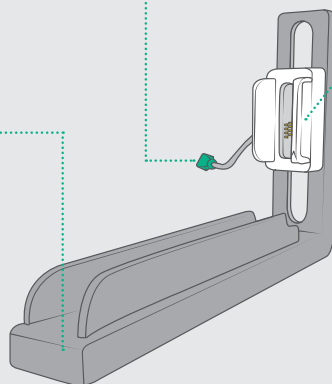
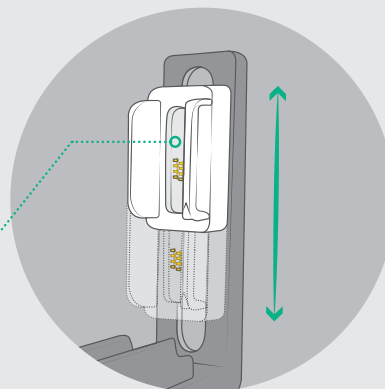

SEEN IN THIS PHOTO

RAM-GDS-DOCK-6G10PU

GDS® 6-Port Charging Module for
IntelliSkin® Phones in Cabinets



CHARGING

Phone Cabinet Module

This charging module supports up to six devices with IntelliSkin® protective sleeves and can be installed along multiple modules in a cabinet with 19" industry standard racks, creating the ideal mass charging solution for a variety of use cases involving a large inventory of usable smart phones, such as museums, tours, warehouses, retail and more. Utilizing the 78W power supply, this charging module delivers 12.5W of power simultaneously to each device drawing from any standard 120V or 220V wall outlet or power strip.

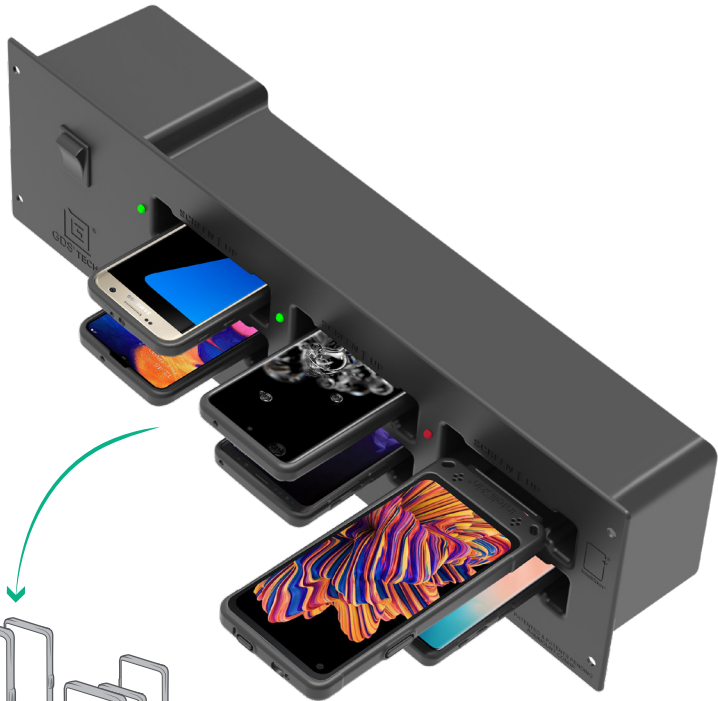

6-Port charging module for any phone with an IntelliSkin® protective case; charges up to 6 devices simultaneously

RAM-GDS-DOCK-6G10PU
GDS® 6-Port Charging Module for IntelliSkin® Phones in Cabinets

FEATURES

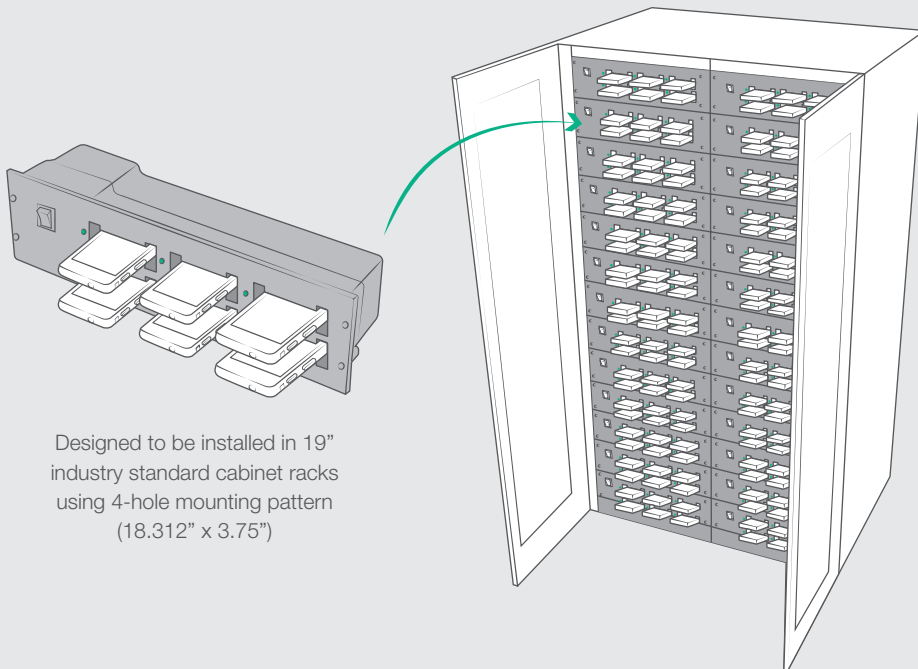

Designed to be installed in 19" industry standard cabinet racks using 4-hole mounting pattern (18.312" x 3.75")

SEEN IN THIS PHOTO

RAM-GDS-CHARGE-V7B1U

GDS® Modular 10-30V
Hardwire Charger with Female
USB Type-A Connector



CHARGING

Hardwire Chargers

Maintain a consistent power connection to your fleet of devices with the GDS® Modular Hardwire Chargers. When it comes time to upgrade, avoid any rewiring by simply unplugging the power connector and attaching the new charger components. As part of GDS® Reach™ enabled by the GDS® Ecosystem™, our solutions work seamlessly to keep devices protected, connected, and charged in nearly any application.



RAM-GDS-CHARGE-V3C-2U

GDS® Modular 10-30V Power Delivery Hardwire Charger with Male USB Type-C



RAM-GDS-CHARGE-V7B1U

GDS® Modular 10-30V Hardwire Charger with Female USB Type-A Connector



RAM-GDS-CHARGE-V8BU

GDS® Modular 30-64V Hardwire Charger with Female USB Type-A Connector

HARDWARE CHARGERS	Output Connector Type	Power Delivery	Legacy USB	Input Voltage	Output Voltage	Input Cable Length	Output Cable Length
RAM-GDS-CHARGE-V3C-2U	USB Type-C Male	Yes	Yes	10 - 30 VDC	5 - 15 VDC	2.5M	1M
RAM-GDS-CHARGE-V3CH-2U	USB Type-C Male	Yes	Yes	30 - 64 VDC	5 - 15 VDC	2.5M	1M
RAM-GDS-CHARGE-V7CU	USB Type-C Male	No	Yes	10 - 30 VDC	5.42 - 9 VDC	2.5M	1M
RAM-GDS-CHARGE-V8CU	USB Type-C Male	No	Yes	30 - 64 VDC	5.42 - 9 VDC	2.5M	1M
RAM-GDS-CHARGE-V7B1U	USB Type-A Female	No	Yes	10 - 30 VDC	5 - 9 VDC	1.2M	200mm
RAM-GDS-CHARGE-V8BU	USB Type-A Female	No	Yes	30 - 64 VDC	5 - 9 VDC	1.2M	200mm

Wall Chargers



USB Type-A
 USB Type-C

RAM-GDS-CHARGE-USBC2W

GDS® Type-C and Type-A 48W Premium 2-Port Wall Charger



USB Type-C

RAM-GDS-CHARGE-USBCW

GDS® Type-C 18W Mini Wall Charger



USB Type-A

RAM-GDS-CHARGE-USB2W

GDS® 2-Port USB Wall Charger

CLA Chargers



USB Type-A
 USB Type-C

RAM-GDS-CHARGE-PPS-C1G

GDS® Type-C and Type A 2-Port Cigarette Charger



USB Type-A

RAM-GDS-CHARGE-USB2QCCIG

GDS® 2-Port USB Cigarette Charger with Qualcomm® Quick Charge™



USB Type-A
 USB Type-C

RAM-GDS-CHARGE-PPS-C2W

GDS® Type-C and Type-A 33W 2-Port Wall Charger

SEEN IN THIS PHOTO:

RAM-GDS-CAB-CLAMP1U

GDS® mUSB & Type-C Cable Clamp



CHARGING

Cables and Cable Retention

When it comes to device safety, it's the little details that matter. Cable retention is a vital piece of the puzzle in maintaining a secure connection between your device and ensuring it does not become unplugged from its power source.

Explore our GDS® cable clamp accessories below to learn how easy cable management and retention can be with the help of RAM® Mounts.



RAM-GDS-CAB-CLAMP1U

GDS® mUSB & Type-C Cable Clamp



RAM-GDS-CAB-CLAMP2U

GDS® USB Type-A Male & Type-A Female Clamp



RAM-GDS-CAB-CLAMP3U

GDS® USB Cable Clamp for Rugged Aluminum USB Housings



RAM-GDS-CAB-MUSB2-2U

GDS® Genuine USB 2.0
Straight 750mm Cable



RAM-GDS-CAB-USBC-AMCMU

GDS® Genuine USB Type-C 3.1 Cable



RAM-GDS-CAB-USBC-CMCFU

GDS® Genuine USB Type-C
800mm Extension Cable



RAM-GDS-CAB-USBC-CMCM-20-10

GDS® Genuine USB Type-C 2.0
Male to Male 1M Cable



RAM-GDS-CAB-USBC-CMCMU

GDS® Genuine USB Type-C 3.1
Male to Male 500mm Cable



RAM-GDS-CAB-MUSB2-1

GDS® Genuine USB 2.0 Straight 1.2M Cable



MAINTENANCE

Care and Maintenance

When it comes to protecting and maintaining your fleet of devices, regular care is important for long-term performance. Learn more about our recommended cleaning, care, and maintenance below.

SUPPLIES

DeoxIT Pen



Cleaning Agent + Q-tips



1

TABLET PREPARATION

Remove factory sleeve from tablet. Pogo pads are recessed from the tablet and the protective sleeve, so removing the sleeve is a vital step ahead of cleaning the pogo pads.



2

CLEANING

Uncap your DeoxIT® Pen, or wet the end of your Q-tip with the cleaning agent and twist in a circular motion against each pogo pad 2-4 times each pad. Check pad for cleanliness and repeat the process until thoroughly cleaned.

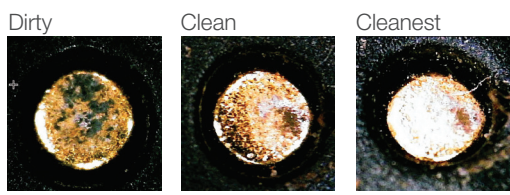
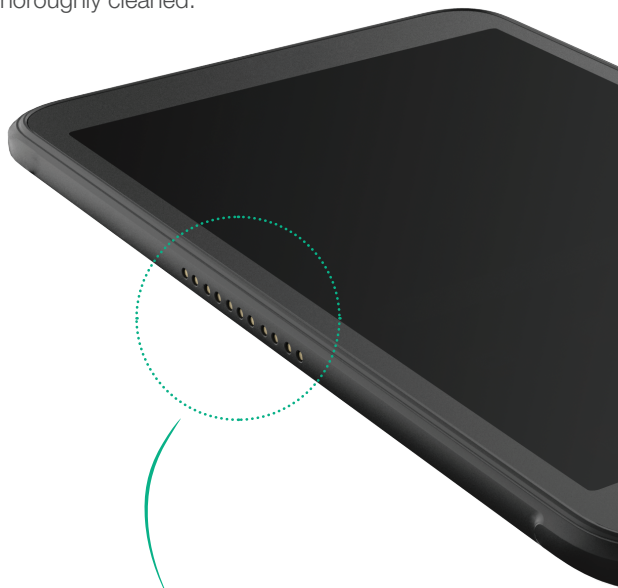

GENERAL CARE & MAINTENANCE

- For spills or accumulated dirt on the GDS® Dock™ pogo pins, gently clean using contact cleaner or alcohol on a cotton swab. Use contact cleaner or alcohol with a stiff brush to clean IntelliSkin® contacts.
- For industrial and heavy use environments, clean pogo pins and contacts on a regular basis.

3-year warranty on all electronic components/Lifetime Warranty on all non-electronic components

The exclusive NPI Lifetime Warranty states that all GDS® non-electronic components and parts are warranted against defect in materials and workmanship for the life of the product or part. NPI's Lifetime Warranty covers the product or its components only. The mount device is not covered under the Lifetime Warranty and will not be replaced if damaged as a result of mount failure. This warranty is expressly limited to persons in the United States, and all foreign countries who purchase GDS® for resale or use in the ordinary course of the buyer's business. This warranty does not cover any product or part that has been abused, worn out, heated, ground or otherwise altered, used for a purchase other than that for which it was intended, or used in a manner inconsistent with any instruction regarding its use.

Apple

All docks have USB Type-C compatible power charging



iPad 10th Generation and iPad Air 5 and iPad Pro 11" 1st-4th Generation

Tough-Docks™				
RAM-GDS-DOCK-AP32CPU	–	–	USB Type-C 2.0	–
RAM-GDS-DOCKKL-AP32CPU	Key-Locking	–	USB Type-C 2.0	–
RAM-GDS-DOCKKF-AP32CPU	–	Cooling Fan	USB Type-C 2.0	–
RAM-GDS-DOCKLF-AP32CPU	Key-Locking	Cooling Fan	USB Type-C 2.0	–
RAM-GDS-DOCK-AP32CU	–	–	USB Type-C 3.1	–
RAM-GDS-DOCKKL-AP32CU	Key-Locking	–	USB Type-C 3.1	–
RAM-GDS-DOCKKF-AP32CU	–	Cooling Fan	USB Type-C 3.1	–
RAM-GDS-DOCKLF-AP32CU	Key-Locking	Cooling Fan	USB Type-C 3.1	–
RAM-GDS-DOCK-AP32CDU	–	–	USB Type-C 2.0	Single USB Type-A Port
RAM-GDS-DOCKKL-AP32CDU	Key-Locking	–	USB Type-C 2.0	Single USB Type-A Port
RAM-GDS-DOCK-AP32CD2U	–	–	USB Type-C 2.0	Dual USB Type-A Ports
RAM-GDS-DOCKKL-AP32CD2U	Key-Locking	–	USB Type-C 2.0	Dual USB Type-A Ports

IntelliSkin® for 10th Gen



RAM-GDS-SKIN-AP40-NG

–

IntelliSkins® for Air 5 And Pro 11"



RAM-GDS-SKIN-AP32-NG

–

RAM-GDS-SKIN-AP32-NG-LED

LED Light



iPad Mini 6

Tough-Docks™				
RAM-GDS-DOCKKL-V10-OMT3U	Key-Locking	–	USB Type-C 2.0	–
RAM-GDS-DOCKKL-V10-OMT3CDU	Key-Locking	–	USB Type-C 2.0	Single USB Type-A Ports
RAM-GDS-DOCKKL-V10-OMT3CD2U	Key-Locking	–	USB Type-C 2.0	Dual USB Type-A Ports

IntelliSkin®



RAM-GDS-SKIN-AP36-NG

–



iPad Pro 12.9" 3rd-6th Generation

Tough-Docks™

	🔑	🌀	🔌	🔌
RAM-GDS-DOCK-AP37CPU	–	–	USB Type-C 2.0	–
RAM-GDS-DOCKL-AP37CPU	Key-Locking	–	USB Type-C 2.0	–
RAM-GDS-DOCKF-AP37CPU	–	Cooling Fan	USB Type-C 2.0	–
RAM-GDS-DOCKLF-AP37CPU	Key-Locking	Cooling Fan	USB Type-C 2.0	–
RAM-GDS-DOCK-AP37CD2U	–	–	USB Type-C 2.0	Dual USB Type-A Ports

IntelliSkin®

	☀️
RAM-GDS-SKIN-AP37-NG	–

SEEN IN THIS PHOTO

RAM-GDS-DOCKL-AP32CDU

Locking GDS® Tough-Dock™ + Single USB for iPad 10th Gen, Air 5 & Pro 11"

RAM-KB2-USB

GDS® Keyboard™ with Track Pad

RAM-VP-SW2F-89

RAM® Tele-Pole™ with 8" & 9" Poles and Double Ball Mount



Samsung

All docks have USB Type-C compatible power charging



Galaxy Tab S7 11"

Tough-Docks™				
RAM-GDS-DOCK-SAM76CU	–	–	USB Type-C 3.1	–
RAM-GDS-DOCKKL-SAM76CU	Key-Locking	–	USB Type-C 3.1	–
RAM-GDS-DOCKKF-SAM76CU	–	Cooling Fan	USB Type-C 3.1	–
RAM-GDS-DOCKLKF-SAM76CU	Key-Locking	Cooling Fan	USB Type-C 3.1	–
RAM-GDS-DOCK-SAM76CPU	–	–	USB Type-C 2.0	–
RAM-GDS-DOCKKL-SAM76CPU	Key-Locking	–	USB Type-C 2.0	–
RAM-GDS-DOCKKF-SAM76CPU	–	Cooling Fan	USB Type-C 2.0	–
RAM-GDS-DOCKLKF-SAM76CPU	Key-Locking	Cooling Fan	USB Type-C 2.0	–

IntelliSkins®	
RAM-GDS-SKIN-SAM76-NG	–
RAM-GDS-SKIN-SAM76-NG-LED	LED Light



Galaxy Tab S8+, S7+, and S7 FE 12.4"

Tough-Docks™				
RAM-GDS-DOCK-SAM78CU	–	–	USB Type-C 3.1	–
RAM-GDS-DOCKKL-SAM78CU	Key-Locking	–	USB Type-C 3.1	–
RAM-GDS-DOCKKF-SAM78CU	–	Cooling Fan	USB Type-C 3.1	–
RAM-GDS-DOCKLKF-SAM78CU	Key-Locking	Cooling Fan	USB Type-C 3.1	–
RAM-GDS-DOCK-SAM78CPU	–	–	USB Type-C 2.0	–
RAM-GDS-DOCKKL-SAM78CPU	Key-Locking	–	USB Type-C 2.0	–
RAM-GDS-DOCKKF-SAM78CPU	–	Cooling Fan	USB Type-C 2.0	–
RAM-GDS-DOCKLKF-SAM78CPU	Key-Locking	Cooling Fan	USB Type-C 2.0	–

IntelliSkins®	
RAM-GDS-SKIN-SAM78-NG	–



Galaxy Tab A7 10.4"

Tough-Docks™	Key-Locking	Cooling Fan	Power	USB
RAM-GDS-DOCK-SAM75CPU	-	-	USB Type-C 2.0	-
RAM-GDS-DOCKL-SAM75CPU	Key-Locking	-	USB Type-C 2.0	-
RAM-GDS-DOCKF-SAM75CPU	-	Cooling Fan	USB Type-C 2.0	-
RAM-GDS-DOCKLF-SAM75CPU	Key-Locking	Cooling Fan	USB Type-C 2.0	-

IntelliSkin®	LED Light
RAM-GDS-SKIN-SAM75-NG	-
RAM-GDS-SKIN-SAM75-NG-LED	LED Light



Galaxy Tab A7 Lite 8.7"

Tough-Docks™	Key-Locking	Cooling Fan	Power	USB
RAM-GDS-DOCK-SAM80CPU	-	-	USB Type-C 2.0	-
RAM-GDS-DOCK-SAM80CDU	-	-	USB Type-C 2.0	Single USB Type-A Port
RAM-GDS-DOCK-SAM80CD2U	-	-	USB Type-C 2.0	Dual USB Type-A Ports
RAM-GDS-DOCKL-SAM80CPU	Key-Locking	-	USB Type-C 2.0	-
RAM-GDS-DOCKL-SAM80CDU	Key-Locking	-	USB Type-C 2.0	Single USB Type-A Port
RAM-GDS-DOCKL-SAM80CD2U	Key-Locking	-	USB Type-C 2.0	Dual USB Type-A Ports

IntelliSkin®	LED Light
RAM-GDS-SKIN-SAM80-NG	-
RAM-GDS-SKIN-SAM80-NG-LED	LED Light



Galaxy Tab A8 10.5"





Tough-Docks™	Key-Locking	Cooling Fan	Power	USB
RAM-GDS-DOCK-SAM83CPU	-	-	USB Type-C 2.0	-
RAM-GDS-DOCK-SAM83CDU	-	-	USB Type-C 2.0	Single USB Type-A Port
RAM-GDS-DOCKL-SAM83CPU	Key-Locking	-	USB Type-C 2.0	-
RAM-GDS-DOCKL-SAM83CDU	Key-Locking	-	USB Type-C 2.0	Single USB Type-A Port

IntelliSkin®	LED Light
RAM-GDS-SKIN-SAM80-NG	-
RAM-GDS-SKIN-SAM80-NG-LED	LED Light



Tab Active3 and Tab Active2

Tough-Docks™

				
RAM-GDS-DOCK-SAM62CPU	–	–	USB Type-C 2.0	–
RAM-GDS-DOCKL-SAM62CPU	Key-Locking	–	USB Type-C 2.0	–
RAM-GDS-DOCKF-SAM62CPU	–	Cooling Fan	USB Type-C 2.0	–
RAM-GDS-DOCKLF-SAM62CPU	Key-Locking	Cooling Fan	USB Type-C 2.0	–
RAM-GDS-DOCK-SAM62CU	–	–	USB Type-C 3.1	–
RAM-GDS-DOCKL-SAM62CU	Key-Locking	–	USB Type-C 3.1	–
RAM-GDS-DOCKF-SAM62CU	–	Cooling Fan	USB Type-C 3.1	–
RAM-GDS-DOCKLF-SAM62CU	Key-Locking	Cooling Fan	USB Type-C 3.1	–
RAM-GDS-DOCK-SAM62CDU	–	–	USB Type-C 2.0	Single USB Type-A Port
RAM-GDS-DOCKL-SAM62CDU	Key-Locking	–	USB Type-C 2.0	Single USB Type-A Port
RAM-GDS-DOCKF-SAM62CDU	–	Cooling Fan	USB Type-C 2.0	Single USB Type-A Port
RAM-GDS-DOCKLF-SAM62CDU	Key-Locking	Cooling Fan	USB Type-C 2.0	Single USB Type-A Port
RAM-GDS-DOCK-SAM62CD2U	–	–	USB Type-C 2.0	Dual USB Type-A Ports
RAM-GDS-DOCKL-SAM62CD2U	Key-Locking	–	USB Type-C 2.0	Dual USB Type-A Ports
RAM-GDS-DOCKF-SAM62CD2U	–	Cooling Fan	USB Type-C 2.0	Dual USB Type-A Ports
RAM-GDS-DOCKLF-SAM62CD2U	Key-Locking	Cooling Fan	USB Type-C 2.0	Dual USB Type-A Ports
RAM-GDS-DOCK-SAM62CP-NFCU	–	–	USB Type-C 2.0	–
RAM-GDS-DOCKL-SAM62CP-NFCU	Key-Locking	–	USB Type-C 2.0	–

IntelliSkins®

	
RAM-GDS-SKIN-SAM74-NG	–
RAM-GDS-SKIN-SAM74-NG-LED	LED Light

SEEN IN THIS PHOTO

RAM-GDS-DOCKL-SAM62CPU
Locking GDS® Tough-Dock™
for Tab Active3 and Tab Active2





Tab Active4 Pro and Tab Active Pro

Tough-Docks™	🔑	🌀	🔌	🔌
RAM-GDS-DOCK-SAM54CPU	-	-	USB Type-C 2.0	-
RAM-GDS-DOCKL-SAM54CPU	Key-Locking	-	USB Type-C 2.0	-
RAM-GDS-DOCKF-SAM54CPU	-	Cooling Fan	USB Type-C 2.0	-
RAM-GDS-DOCKLF-SAM54CPU	Key-Locking	Cooling Fan	USB Type-C 2.0	-
RAM-GDS-DOCK-SAM54CU	-	-	USB Type-C 3.1	-
RAM-GDS-DOCKL-SAM54CU	Key-Locking	-	USB Type-C 3.1	-
RAM-GDS-DOCKF-SAM54CU	-	Cooling Fan	USB Type-C 3.1	-
RAM-GDS-DOCKLF-SAM54CU	Key-Locking	Cooling Fan	USB Type-C 3.1	-
RAM-GDS-DOCK-SAM54CD2U	-	-	USB Type-C 2.0	Dual USB Type-A Ports

IntelliSkin®	☀️
RAM-GDS-SKIN-SAM54-NG-1	-



Galaxy Tab A 8.4"

Tough-Docks™	🔑	🌀	🔌	🔌
RAM-GDS-DOCK-SAM67CPU	-	-	USB Type-C 2.0	-
RAM-GDS-DOCKL-SAM67CPU	Key-Locking	-	USB Type-C 2.0	-
RAM-GDS-DOCKF-SAM67CPU	-	Cooling Fan	USB Type-C 2.0	-
RAM-GDS-DOCKLF-SAM67CPU	Key-Locking	Cooling Fan	USB Type-C 2.0	-
RAM-GDS-DOCK-SAM67CU	-	-	USB Type-C 3.1	-
RAM-GDS-DOCKL-SAM67CU	Key-Locking	-	USB Type-C 3.1	-
RAM-GDS-DOCKF-SAM67CU	-	Cooling Fan	USB Type-C 3.1	-
RAM-GDS-DOCKLF-SAM67CU	Key-Locking	Cooling Fan	USB Type-C 3.1	-
RAM-GDS-DOCK-SAM67CDU	-	-	USB Type-C 2.0	Single USB Type-A Port

IntelliSkin®	☀️
RAM-GDS-SKIN-SAM67-NG	-
RAM-GDS-SKIN-SAM67-NG-LED	LED Light

LEGACY GDS® & INTELLISKIN® PRODUCTS

MAKE	MODEL	INTELLISKIN®	VEHICLE DOCK
TABLETS Apple	iPad 5th & 6th Gen	RAM-GDS-SKIN-AP15	RAM-GDS-DOCKL-V2-AP8U
	iPad mini 4 & 5	RAM-GDS-SKIN-AP27	RAM-GDS-DOCKL-V2-AP27U
	iPad Pro 10.5 & Air 3	RAM-GDS-SKIN-AP16	RAM-GDS-DOCKL-V2-AP16U
	iPad Pro 11 2nd & 3rd Gen	RAM-GDS-SKIN-AP23-A	RAM-GDS-DOCKL-V2-AP23CPU
	iPad Pro 12.9 3rd, 4th & 5th Gen	RAM-GDS-SKIN-AP24-A	RAM-GDS-DOCKL-V2-AP24CPU
TABLETS Samsung	Galaxy Tab 4 10.1	RAM-GDS-SKIN-SAM13U	RAM-GDS-DOCKT-SAM13U RAM-HOL-TABLBU RAM-GDS-DOCK-V5BU
	Galaxy Tab 4 7.0	RAM-GDS-SKIN-SAM11U	RAM-GDS-DOCKT-SAM11U RAM-HOL-TABLBU RAM-GDS-DOCK-V5BU
	Galaxy Tab 4 8.0	RAM-GDS-SKIN-SAM12U	RAM-GDS-DOCKT-SAM12U RAM-HOL-TABLBU RAM-GDS-DOCK-V5BU
	Galaxy Tab A 10.1	RAM-GDS-SKIN-SAM23	RAM-GDS-DOCKT-SAM23U RAM-HOL-TABLBU RAM-GDS-DOCK-V5BU
	Galaxy Tab A 10.1 (2019)	RAM-GDS-SKIN-SAM50	RAM-GDS-DOCKL-V2-SAM49U
	Galaxy Tab A 10.1 with S Pen	RAM-GDS-SKIN-SAM26	RAM-GDS-DOCKT-SAM23U RAM-HOL-TABLBU RAM-GDS-DOCK-V5BU
	Galaxy Tab A 10.5	RAM-GDS-SKIN-SAM43	RAM-GDS-DOCKL-V2-SAM43U
	Galaxy Tab A 7.0	RAM-GDS-SKIN-SAM24	RAM-GDS-DOCKT-SAM24U RAM-HOL-TABLBU RAM-GDS-DOCK-V5BU
	Galaxy Tab A 8.0 (2015)	RAM-GDS-SKIN-SAM16U	RAM-GDS-DOCKT-SAM16U RAM-HOL-TABLBU RAM-GDS-DOCK-V5BU
	Galaxy Tab A 8.0 (2017)	RAM-GDS-SKIN-SAM35	RAM-GDS-DOCKL-V2-SAM35U
	Galaxy Tab A 8.0 (2017)	RAM-GDS-SKIN-SAM40	RAM-GDS-DOCKL-V2-SAM40CU
	Galaxy Tab A 9.7	RAM-GDS-SKIN-SAM15U	RAM-GDS-DOCKL-V2-SAM15U
	Galaxy Tab Active2	RAM-GDS-SKIN-SAM29H	RAM-GDS-DOCKL-V2-SAM29CU
	Galaxy Tab E 8.0	RAM-GDS-SKIN-SAM21	RAM-GDS-DOCKT-SAM21U RAM-HOL-TABLBU RAM-GDS-DOCK-V5BU
	Galaxy Tab E 9.6	RAM-GDS-SKIN-SAM20U	RAM-GDS-DOCKT-SAM20U RAM-HOL-TABLBU RAM-GDS-DOCK-V5BU
	Galaxy Tab S 10.5	RAM-GDS-SKIN-SAM10U	RAM-GDS-DOCKT-SAM10U RAM-HOL-TABLBU RAM-GDS-DOCK-V5BU
	Galaxy Tab S 8.4	RAM-GDS-SKIN-SAM9U	RAM-GDS-DOCKT-SAM9U RAM-HOL-TABLBU RAM-GDS-DOCK-V5BU
	Galaxy Tab S2 8.0	RAM-GDS-SKIN-SAM18U	RAM-GDS-DOCKT-SAM18U RAM-HOL-TABLBU RAM-GDS-DOCK-V5BU
	Galaxy Tab S2 9.7	RAM-GDS-SKIN-SAM19U	RAM-GDS-DOCKT-SAM19U RAM-HOL-TABLBU RAM-GDS-DOCK-V5BU
	Galaxy Tab S3 9.7	RAM-GDS-SKIN-SAM27	RAM-GDS-DOCKT-SAM27U RAM-HOL-TABLBU RAM-GDS-DOCK-V5BU
Galaxy Tab S4 10.5	RAM-GDS-SKIN-SAM41	RAM-GDS-DOCKL-V2-SAM41U	
Galaxy Tab S5e	RAM-GDS-SKIN-SAM49	RAM-GDS-DOCKL-V2-SAM49U	

MAKE	MODEL	INTELLISKIN®	VEHICLE DOCK
PHONES Samsung	Galaxy A10	RAM-GDS-SKIN-SAM56	RAM-GDS-DOCK-V1CPU
	Galaxy A20	RAM-GDS-SKIN-SAM61	
	Galaxy J3 (2016)	RAM-GDS-SKIN-SAM25	
	Galaxy J3 (2017)	RAM-GDS-SKIN-SAM31	
	Galaxy J3 (2018)	RAM-GDS-SKIN-SAM44	
	Galaxy J7 (2018)	RAM-GDS-SKIN-SAM45	
	Galaxy Note 9	RAM-GDS-SKIN-SAM42	
	Galaxy S10	RAM-GDS-SKIN-SAM46	
	Galaxy S10+	RAM-GDS-SKIN-SAM48	
	Galaxy S10e	RAM-GDS-SKIN-SAM47	
	Galaxy S20 5G	RAM-GDS-SKIN-SAM69	
	Galaxy S20 FE 5G	RAM-GDS-SKIN-SAM77	
	Galaxy S20 Ultra 5G	RAM-GDS-SKIN-SAM71	
	Galaxy S20+ 5G	RAM-GDS-SKIN-SAM70	
	Galaxy S6	RAM-GDS-SKIN-SAM14U	
	Galaxy S7	RAM-GDS-SKIN-SAM22	
	Galaxy S8	RAM-GDS-SKIN-SAM28	
	Galaxy S8+	RAM-GDS-SKIN-SAM30	
	Galaxy S9	RAM-GDS-SKIN-SAM39	
	Galaxy XCover 4	RAM-GDS-SKIN-SAM37	
Galaxy XCover 4s	RAM-GDS-SKIN-SAM51		
Galaxy XCover Pro	RAM-GDS-SKIN-SAM59		

RAM-GDS-DOCK-D1AU

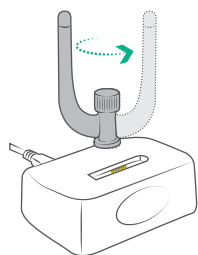

The Adjustable GDS® Desktop Charger supports a variety of devices including tablets, smartphones, phablets, devices wrapped with IntelliSkin®, or any device compatible with GDS® technology.

RAM-GDS-DOCK-D1U

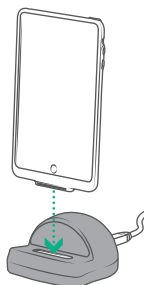

Heavy-duty docking and charging base for any device equipped with an IntelliSkin® sleeve including electronic devices. It provides HD data connectivity and an extra-heavy base for stability of larger devices and frequent docking and undocking common in commercial applications.

RAM-GDS-AD1U

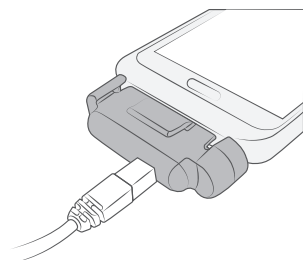

The Snap-Con™ GDS to Micro USB 2.0 Adaptor enables on the go charging and data connectivity of any GDS® compatible device, including devices wrapped in IntelliSkin®, using an included Micro USB 2.0 cable.

RAM-GDS-DOCK-4G1PU

RAM-GDS-DOCK-6G1PU

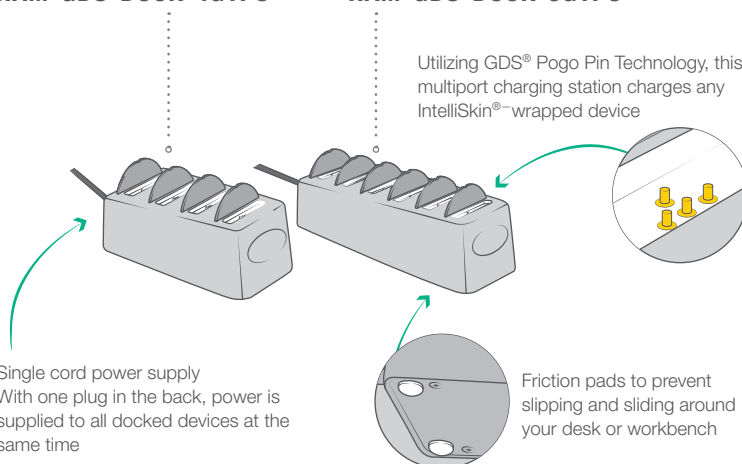

Utilizing GDS® Pogo Pin Technology, this multiport charging station charges any IntelliSkin®-wrapped device

Single cord power supply
 With one plug in the back, power is supplied to all docked devices at the same time

Friction pads to prevent slipping and sliding around your desk or workbench



Mount Anything, Anywhere

gdstech.com
1.800.497.7479
sales@rammount.com



GDS®, IntelliSkin®, GDS® Tech™, GDS® Technology™, GDS® Green™, GDS® Reach™, and GDS® Compatible™ are trademarks or registered trademarks of National Products Inc.

The distinctive D Shape™ of the GDS® connector is a trademark of National Products Inc.



RAM® double socket arms with their distinctive Hourglass Shape are recognized globally as a symbol of the reliability, quality, and durability of this line of products. The Hourglass Shape is a registered trademark of National Products Inc.



The distinctive RAM® "X-Grip®" product shape is a trademark of National Products Inc.



Look for the highly recognizable "Double Delta" trademark, the symbol of quality and reliability

NATIONAL PRODUCTS INC. PRODUCTS DISCLAIMER & LEGAL INFO • RAMMOUNT.COM/IP

NEVER USE MOBILE COMPUTING OR COMMUNICATION EQUIPMENT WHILE A VEHICLE IS IN MOTION

RAM® Mounts are designed for dynamic mounting applications but are not intended to be used in excess of reasonable load limits. National Products Inc., maker of RAM® Mounts, expressly denies any liability for a product failure and assumes no responsibility for lost or damaged mounting systems. National Products Inc. assumes no liability for injuries or any other losses sustained while using these products. RAM® Mounts should not be used in such a manner as to distract the operator from the operation of vehicles or other devices, or to create any safety hazards.

D® product shape, "Hourglass" product shape, 3-D Float, Adapt-A-Post, Adapt-To-RAM, Add-A-Ball, Adjust-A-Pole, Always Protected, Always Connected, Aqua Box, Aqua-Box, Bond-A-Base, D Shape, Dock-N-Lock, Drop-N-Lock, EZ-On/Off, EZ-Roll'r, EZ-Strap, EZY-Mount, Finger-Grip, Flex-Arm, Flex-Base, Flex-Lens, Flex-Rod, GDS, GDS Audio, GDS Case, GDS Charge, GDS Compatible, GDS Cradle, GDS Cup, GDS Dock, GDS Ecosystem, GDS Ergo, GDS Green, GDS Hub, GDS Keyboard, GDS Service, GDS Skin, GDS Sleeve, GDS Tech, GDS Technology, GDS View, Go-Dock, Hand-Track, HandStand, Handi-Case, IntelliSkin, IntelliSkin Compatible, IntelliSkin HD, Just RAM It!, Latch-N-Lock, Level Cup, Level-Base, Light-Speed, LI Buddy, MDT-Mate, Mari-Nut, Mari-Rivet, Mighty-Buddy, Mirror-Mate, Multi-Pad, No-Drill, Power Caddy, Power Plate, Power-Grip, Press-N-Lock, Quick Snap, Quick-Draw, Quick-Grip, RAM, RAM "X-Grip" product shape, RAM Bow-Cam, RAM Compatible, RAM Mount, RAM Mounting Systems, RAM Mounts, RAM Mounts Compatible, RAM Pin-Lock, RAM Pod, RAM Pod HD, RAM ROD, RAM Ratchet, RAM Ratchet Arm, RAM Ratchet Swing Arm, RAM Tube, RAM Tube Jr, RAM X-Grip, RAM-A-CAN, RAM-A-SNACK, Remove-A-Pole, Roller-Ball, Roto-View, Round-A-Mount, Safe-N-Secure, Safe-T-Charge, Seat Mate, Seat-Mate, Secure-N-Motion, Shock Buster, Slide Dock, Slide-N-Lock, Snap-On, Snap-Link, Stack-N-Stow, Stubby, Tab-Lock, Tab-Tite, Team RAM, Tele-Mount, Tele-Pole, Tilt-N-Turn, Torque, Torque-Track, Tough-Ball, Tough-Box, Tough-Clamp, Tough-Claw, Tough-Cleat, Tough-Clip, Tough-Dock, Tough-Hub, Tough-Pole, Tough-Tap, Tough-Track, Tough-Tray, Tough-Tube, Tough-Wedge, Track Ball, Track-Node, Twist-Lock, Twist-N-Tilt, Twist-N-Turn, Uni-Conn, Wedge-Lock, Your Best Connection, are either registered trademarks or trademarks of National Products Inc. in the United States and or other countries.